

CREATING BEAUTY TOGETHER

We believe that everyone has their own unique ideas and creativity, embodying your preferences and needs in the design process, and unleashing the wisdom of life and the charm of art. Accompanying you with professional service capabilities throughout the entire process, interpreting space art together, and creating your exclusive personalized space

我们相信每个人都有自己的独特想法和创意，在设计过程中具象化您的喜好和需求，发挥生活的智慧和艺术的魅力。全程以专业的服务能力陪伴您，共同诠释空间艺术，打造您的专属个性化空间

CUSTOM COLOR:

颜色定制



INDEX

目录

-
- 006 **SUITE SERIES**
套装系列 .

 - 072 **CONCEALED SHOWER SET**
暗装系列 .

 - 096 **SHOWER SET**
豪华淋浴 .

 - 119 **FLOOR-STANDING/ BATHTUB FUACET**
落地 / 缸边浴缸龙头系列 .

 - 123 **BASIN MIXER SERIES**
面盆龙头 .

 - 142 **KITCHEN MIXER SERIES**
厨房龙头 .

 - 147 **ACCESSORIES**
感应 / 水嘴 / 角阀 .

 - 151 **BATHROOM ACCESSORIES**
电热毛巾架 / 浴室挂件 .

 - 164 **ACCESSORIES**
配件
-



完整的 供应链 管理

地处卫浴生产基地，优化采购供应链，满足外购物料的价廉物优的管理模式，做好成本管控和向客户提供更快、更优质的交货服务。

COMPLETE SUPPLY CHAIN MANAGEMENT

Located in the sanitary production distribution center, it optimizes the procurement supply chain, meets the management mode of low price and high quality of purchased materials, performs cost control and provides customers with faster and better delivery services.



全覆盖的 生产能力

全产业链闭环生产，多头做到尾，掌控着和平制造的核心技术，生产制造能力在行业中居前，有高精密的生产设备，可以满足到任何的加工质量要求。

全供应链 生产

从零件加工到整组卫浴龙头的生产 --- 有强大的成本优势和快速反应的生产制造能力。

FULL SUPPLY CHAIN PRODUCTION

From parts processing to the production of the whole set of sanitary faucets -- it has a strong cost advantage and fast reaction production and manufacturing capacity.



FULL COVERAGE OF PRODUCTION CAPACITY

The whole industry chain is closed loop production, with many companies at the end of the chain. It controls the core technology of Peace Manufacturing. Its production and manufacturing capacity ranks first in the industry. It has high-precision production equipment, which can meet any processing quality requirements.



强大的 品质保障 体系

高标准的质量来自于严格的质量控制体系，我们有完整的、严格的生产过程质量管控体系，检测管控设备，可以全方位的满足客户的合理需求，保障产品质量。

STRONG QUALITY ASSURANCE SYSTEM

High standard quality comes from a strict quality control system. We have a complete and strict production process quality control system and testing control equipment, which can meet the reasonable needs of customers in an all-round way and ensure product quality.



WELL BUILT TALENT ECHELON

The company has invested heavily in talent allocation, marketing, production, R&D, quality and other aspects to build a talent echelon to meet the high quality and high-tech needs of various products of middle and high-end customers.

人才 梯队 构建良好

公司在人才配备上投入极大，营销、生产、研发、品质等方面，构建人才梯队建设，以满足中高端客户的各类产品的高质量、高技术需求。

3 FUNCTION SHOWER

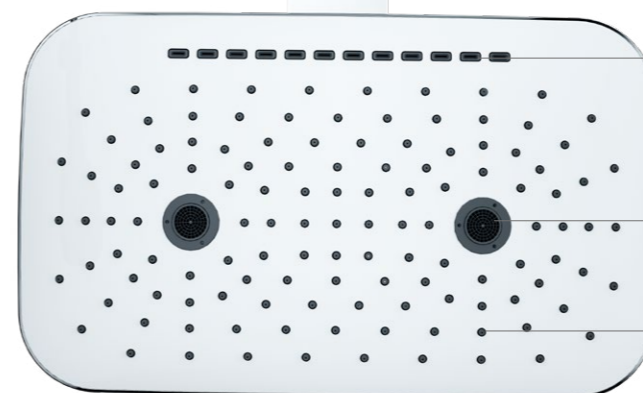

WATERFALL
瀑布

SPOUT
雨柱

RAIN
雨淋

三功能顶喷花洒



20001

五功能明装恒温花洒
5-Function constant temperature
Shower set

主体材质: 铜 + ABS / Material: Brass + ABS

- 亮铬 Chrome
- 枪灰 Gun grey

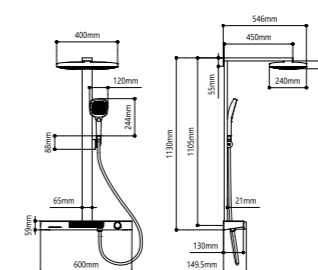

20002

五功能暗装恒温花洒
5-Function constant temperature
Shower set

主体材质: 铜 + ABS / Material: Brass + ABS

- 亮铬 Chrome
- 枪灰 Gun grey

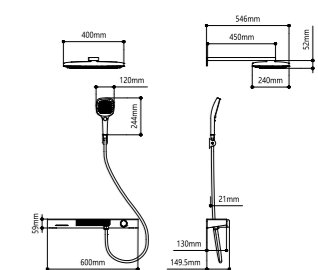



20013
三功能明装花洒
3-Function Shower set
主体材质：铜 /Material: Brass

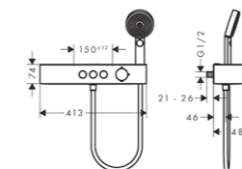

20011
单把面盆龙头
Single handle basin faucet
主体材质：铜 /Material: Brass

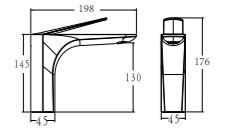

20012
单把面盆龙头
Single handle basin faucet
主体材质：铜 /Material: Brass

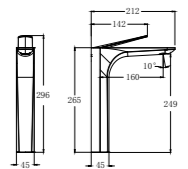

20014
三功能明装花洒
3-Function Shower set
主体材质：铜 /Material: Brass

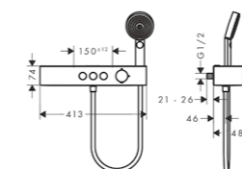

20015
二功能简易花洒
2-Function Simple Shower
主体材质：铜 /Material: Brass

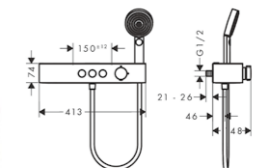



20021

单把面盆龙头
Single handle basin faucet
主体材质: 铜 / Material: Brass

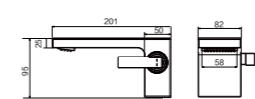

20022

单把入墙面盆龙头
Single handle in-wall basin faucet
主体材质: 铜 / Material: Brass

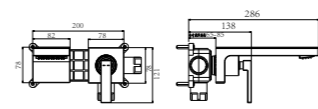

20023

三功能恒温明装花洒
3-Function Shower set
主体材质: 铜 / Material: Brass

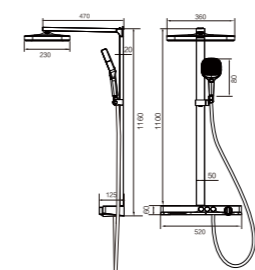

20024

四功能恒温明装花洒
4-Function Shower set
主体材质: 铜 / Material: Brass

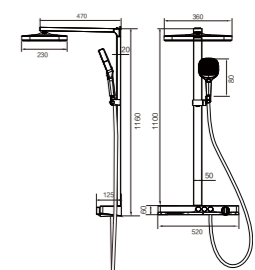



20025
三功能恒温明装花洒
3-Function Shower set
主体材质：铜 /Material: Brass

- C B W Q LG

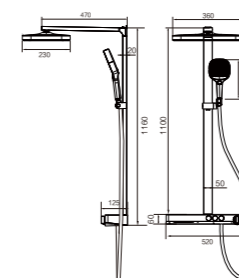

20026
三功能恒温暗装花洒
3-Function In-wall Shower
主体材质：铜 /Material: Brass

- C B W Q LG

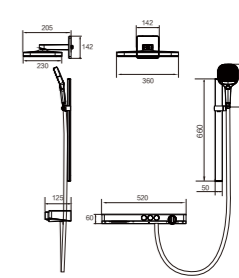



LIFE ATTITUDE

一天的生活从卫浴间开始，也是从卫浴间结束，最关乎一个人的生活态度。

A day's life starts and ends from the bathroom, which is most related to a person's life attitude.



潜心寻觅灵感，产品格调自成一派。超大置物台，洗漱用品轻松收纳。

Dedicated to looking for inspiration, product style into its own school. Oversized counter, easy storage of toiletries.

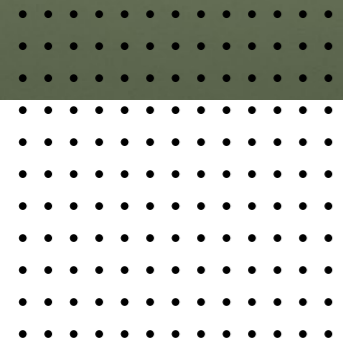
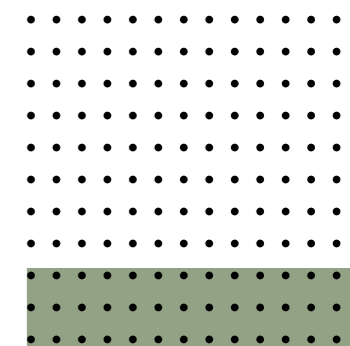



20031

三功能暗装花洒
3-Function In-wall Shower

主体材质：铜 /Material: Brass

C Q LG

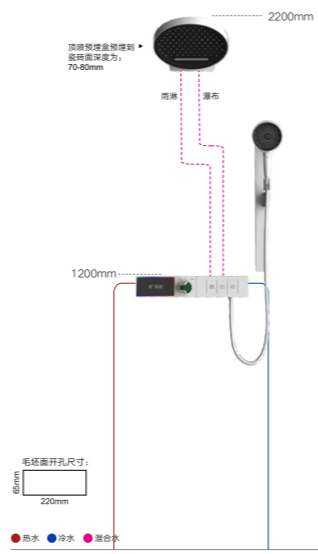
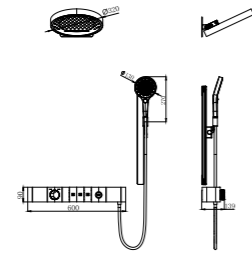

20032

三功能暗装花洒
3-Function In-wall Shower

主体材质：铜 /Material: Brass

C Q LG

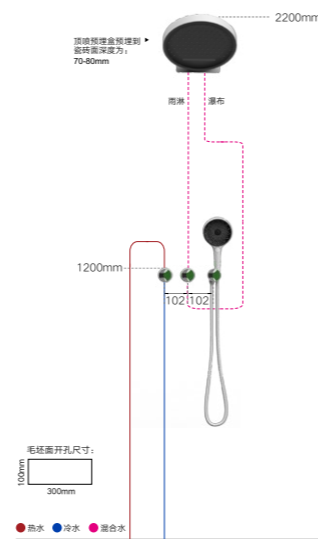
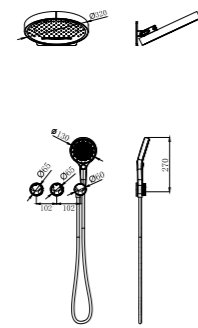

20033

三功能暗装花洒
3-Function In-wall Shower

主体材质：铜 /Material: Brass

C Q LG

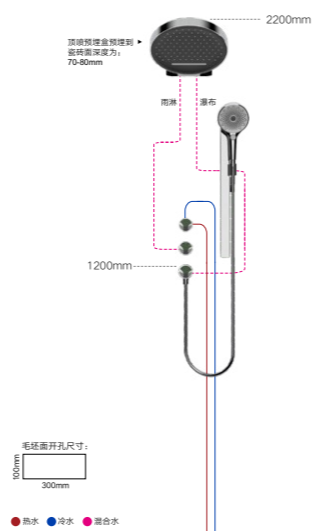
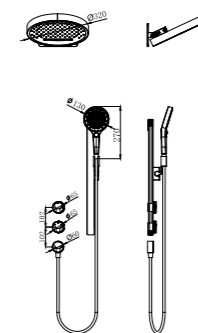

20034

三功能暗装花洒
3-Function In-wall Shower

主体材质：铜 /Material: Brass

C Q LG

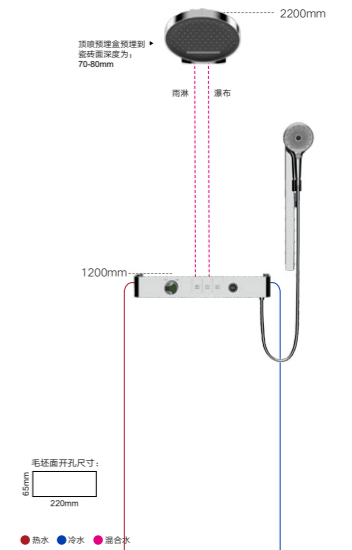
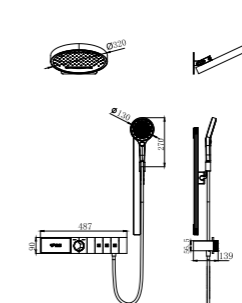



20035

单把面盆龙头
Single handle basin faucet
主体材质：铜 /Material: Brass

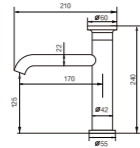

20036

单把面盆龙头
Single handle basin faucet
主体材质：铜 /Material: Brass

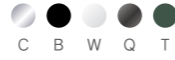
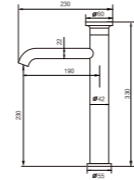

20037

单把面盆龙头
Single handle basin faucet
主体材质：铜 /Material: Brass

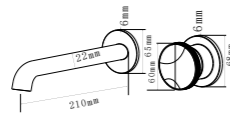

20038

单把面盆龙头
Single handle basin faucet
主体材质：铜 /Material: Brass

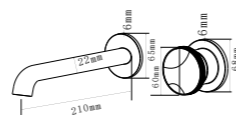

20039

单把面盆龙头
Single handle basin faucet
主体材质：铜 /Material: Brass



20040

单把面盆龙头
Single handle basin faucet
主体材质：铜 /Material: Brass



20041

单把面盆龙头
Single handle basin faucet

主体材质：铜 /Material: Brass

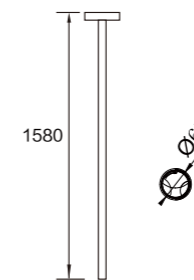

20042

单把面盆龙头
Single handle basin faucet

主体材质：铜 /Material: Brass

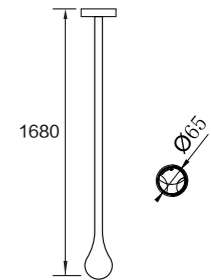



20043

单把立柱面盆龙头
Single handle basin faucet

主体材质：铜 /Material: Brass

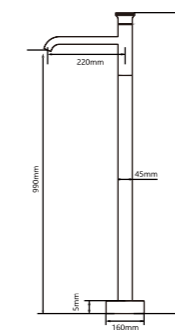

20044

单把落地浴缸龙头
Single handle floor bath faucet

主体材质：铜 /Material: Brass

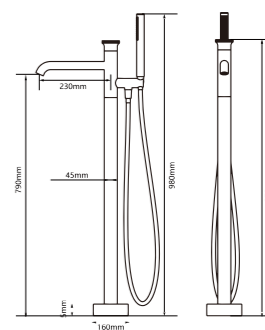

20045

单把立柱面盆龙头
Single handle basin faucet

主体材质：铜 /Material: Brass

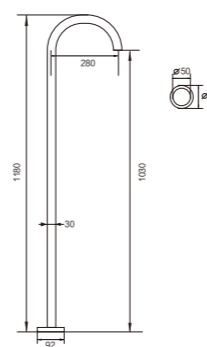

20046

单把落地浴缸龙头
Single handle floor bath faucet

主体材质：铜 /Material: Brass

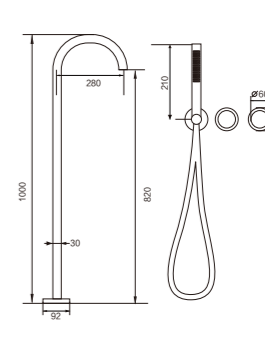



20051
单把面盆龙头
Single handle basin faucet
主体材质：铜 /Material: Brass

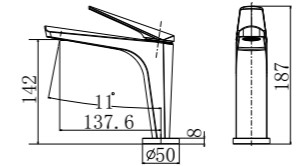

20052
单把面盆龙头
Single handle basin faucet
主体材质：铜 /Material: Brass

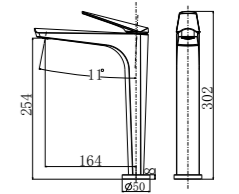
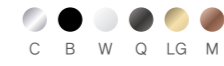

20053
单把厨房龙头
Single handle kitchen mixer
主体材质：铜 /Material: Brass

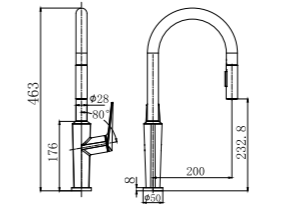

20054
单把浴缸龙头
Single handle bathtub faucet
主体材质：铜 /Material: Brass

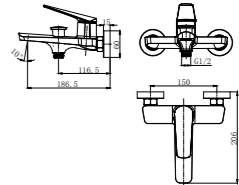
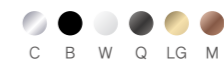

20055
三功能明装花洒
3-Function Shower set
主体材质：铜 /Material: Brass

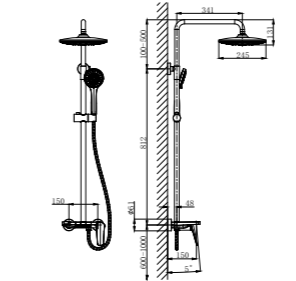

20056
二功能暗装花洒
2-Function In-wall Shower
主体材质：铜 /Material: Brass

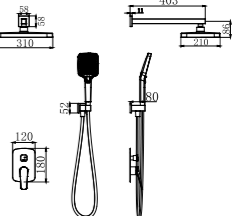
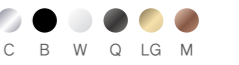

20050
单把入墙面盆龙头
Single handle basin faucet
主体材质：铜 /Material: Brass

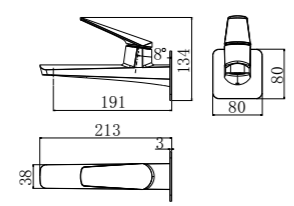

PRIVATE LIVING SPACES

The sculpted silhouette paired with smooth surfaces and textured patterns creates a charming collection that enriches private living spaces with beautiful, well crafted, and reliable items.



20065

单把浴缸龙头
Single handle Bathtub Faucet
主体材质: 铜 /Material: Brass

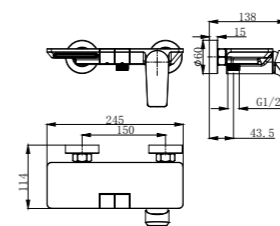
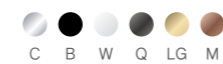

20066

二功能暗装花洒
2-Function In-wall Shower
主体材质: 铜 /Material: Brass

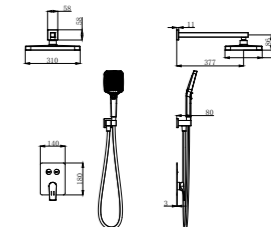

20061

单把面盆龙头
Single handle basin faucet
主体材质: 铜 /Material: Brass

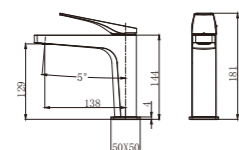

20062

单把入墙面盆龙头
Single handle basin faucet
主体材质: 铜 /Material: Brass

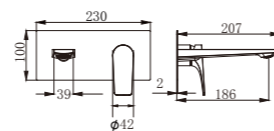

20063

单把面盆龙头
Single handle basin faucet
主体材质: 铜 /Material: Brass

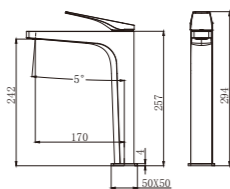

20064

单把抽拉厨房龙头
Pull-out kitchen mixer
主体材质: 铜 /Material: Brass

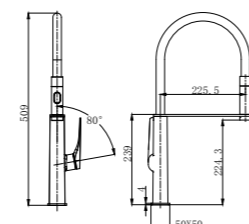

20067

二功能明装花洒
2-Function Shower set
主体材质: 铜 /Material: Brass

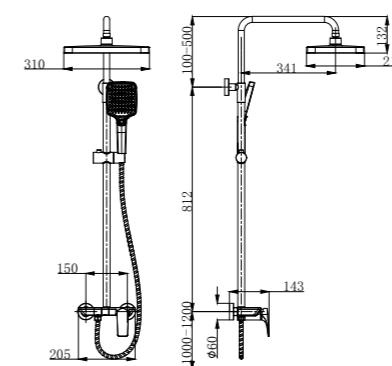
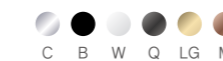

20068

三功能明装花洒
3-Function Shower set
主体材质: 铜 /Material: Brass

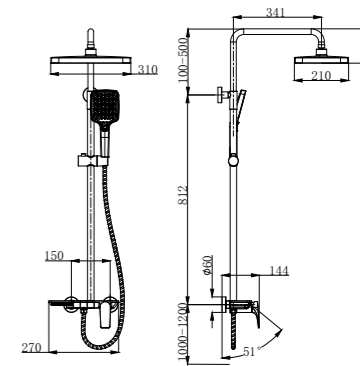



20071

单把面盆龙头
Single handle basin faucet
主体材质: 铜 /Material: Brass

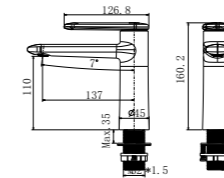

20072

单把面盆龙头
Single handle basin faucet
主体材质: 铜 /Material: Brass

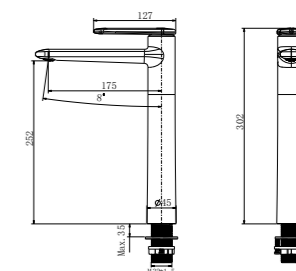

20073

单把入墙面盆龙头
In-wall basin faucet
主体材质: 铜 /Material: Brass

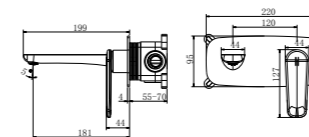

20074

单把入墙面盆龙头
In-wall basin faucet
主体材质: 铜 /Material: Brass

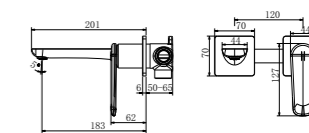

20075

单把抽拉厨房龙头
Pull-out kitchen mixer
主体材质: 铜 /Material: Brass

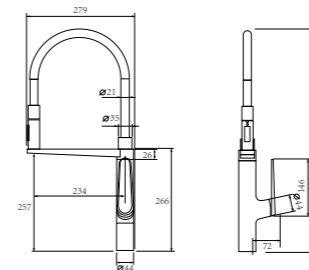

20076

单把抽拉厨房龙头
Pull-out kitchen mixer
主体材质: 铜 /Material: Brass

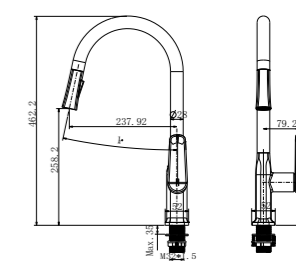



3function

三功能恒温淋浴花洒套装

Farewell to the hustle and bustle of the city, stop at the flowing water villa, live in the sunrise, sunset and rest, then natural melody, return to the essence of life, every time open, such as water to move people. Freyrosen, so simple, so quiet

告别喧嚣都市，停歇于流水别墅间，日出而居，日落而歇自然的旋律，回归生活本质，每一次开启，如流水般打动人心的产品系列，极简如此，安静如斯



20081 (可选恒温 / 冷热)

三功能明装花洒
3-Function Shower set
主体材质：铜 / Material: Brass



20082 (可选恒温 / 冷热)

二功能简易花洒
2-Function Simple Shower
主体材质：铜 / Material: Brass

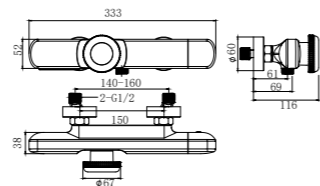

20083

单把面盆龙头
Single handle basin faucet
主体材质：铜 / Material: Brass

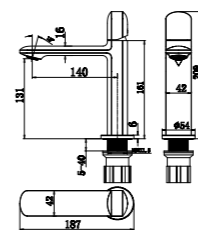

20084

单把面盆龙头
Single handle basin faucet
主体材质：铜 / Material: Brass

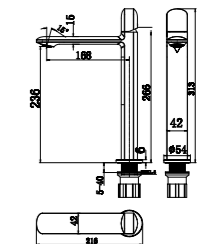

20085

单把面盆龙头
Single handle basin faucet
主体材质：铜 / Material: Brass

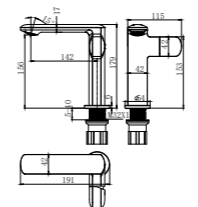

20086

单把面盆龙头
Single handle basin faucet
主体材质：铜 / Material: Brass

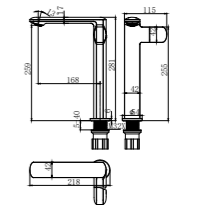

3 function

三功能淋浴花洒套装

使用者站在顶喷下，任由细密水滴轻柔包裹身体，仿如沉浸在浩瀚星河洗礼，让身体和心理同时得以放松。值得一提的是，它还可调节角度，在不洗头的日子里，避免淋湿头发。单功能与 2 功能的完美切换，解锁淋浴与放松的核心乐趣。

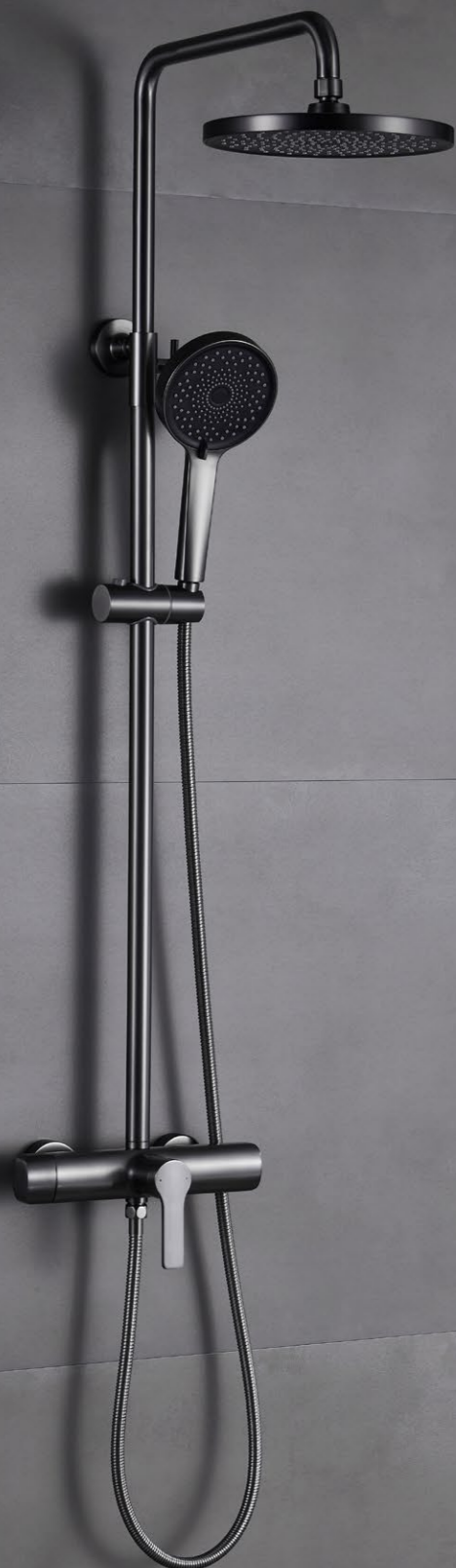

20091

三功能明装花洒

3-Function Shower set

主体材质：铜 / Material: Brass

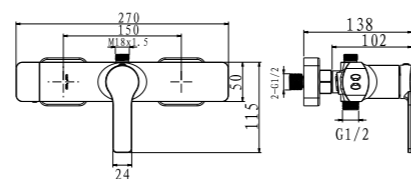

20092

单把面盆龙头

Single handle basin faucet

主体材质：铜 / Material: Brass

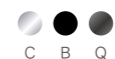
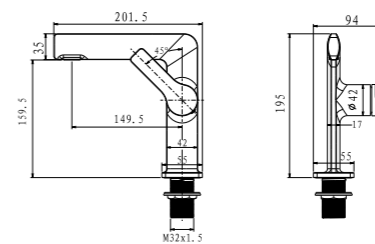

20093

单把面盆龙头

Single handle basin faucet

主体材质：铜 / Material: Brass

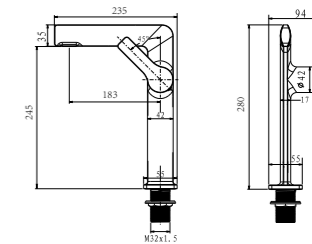

20094

单把抽拉厨房龙头

Pull-out kitchen mixer

主体材质：铜 / Material: Brass

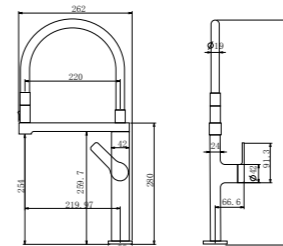

20095

单把抽拉厨房龙头

Pull-out kitchen mixer

主体材质：铜 / Material: Brass

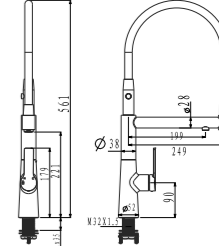

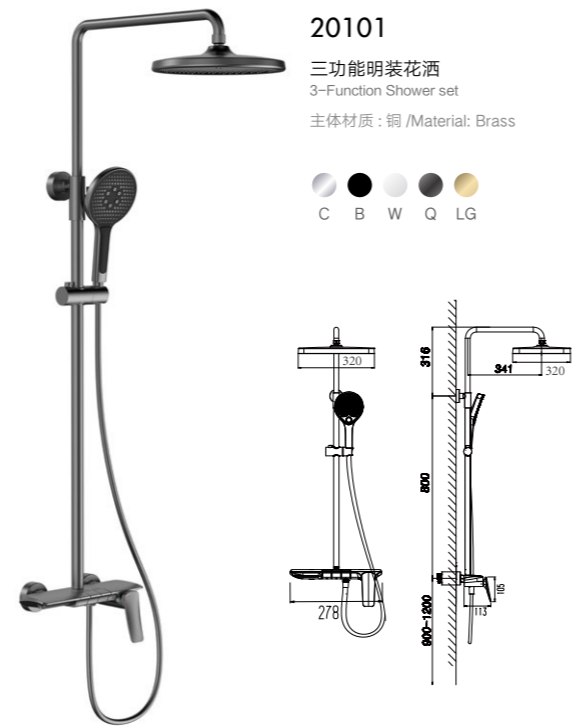

20101
三功能明装花洒
3-Function Shower set
主体材质：铜 /Material: Brass

C B W Q LG



20103
单把面盆龙头
Single handle basin faucet
主体材质：铜 /Material: Brass

C B W Q LG



20104
单把面盆龙头
Single handle basin faucet
主体材质：铜 /Material: Brass

C B W Q LG



20102
二功能暗装花洒
2-Function In-wall Shower
主体材质：铜 /Material: Brass

C B W Q LG



20105
单把入墙面盆龙头
Single handle basin faucet
主体材质：铜 /Material: Brass

C B W Q LG



20106
单把抽拉厨房龙头
Pull-out kitchen mixer
主体材质：铜 /Material: Brass

C B W Q LG



20107
单把浴缸龙头
Single handle Bathtub Faucet
主体材质：铜 /Material: Brass

C B W Q LG



20108
单把淋浴龙头
Single shower faucet
主体材质：铜 /Material: Brass

C B W Q LG



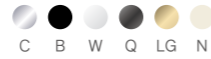

20111

单把面盆龙头
Single handle basin faucet
主体材质: 铜 /Material: Brass

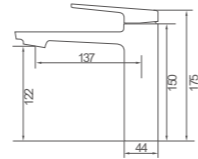

20112

单把面盆龙头
Single handle basin faucet
主体材质: 铜 /Material: Brass

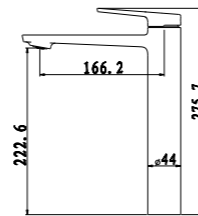

20113

单把抽拉面盆龙头
Pull-out basin faucet
主体材质: 铜 /Material: Brass

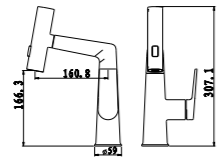

20114

单把抽拉厨房龙头
Pull-out kitchen mixer
主体材质: 铜 /Material: Brass

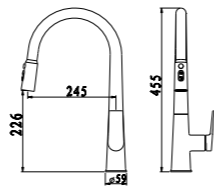

20115

单把入墙面盆龙头
Single handle basin faucet
主体材质: 铜 /Material: Brass

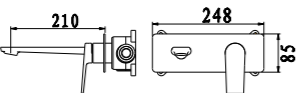

20116

单把浴缸龙头
Single handle Bathtub Faucet
主体材质: 铜 /Material: Brass

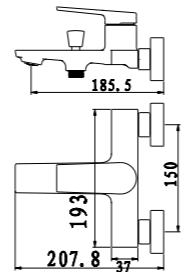

20117

三功能明装花洒
3-Function Shower set
主体材质: 铜 /Material: Brass

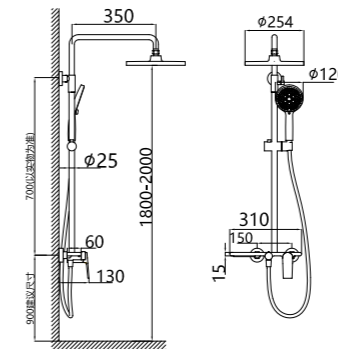

20118

二功能简易花洒
2-Function Simple Shower
主体材质: 铜 /Material: Brass

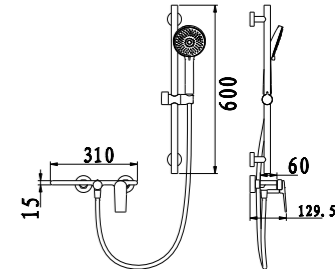



Rose

uch as light, wanton dance, take care to empty,
instantly close your eyes to listen, quietly whisper,
elegant calm, through the light, publicity and
profound, quiet and dynamic, highlighting the ultimate
classic charm.

如光，肆意舞动，当心放空，顷刻闭眼倾听，轻声
细语，优雅从容透过光芒，张扬又深邃，沉静又动感，
彰显极致经典魅力

20121

双把分体面盆龙头
Single handle basin faucet

主体材质：铜 / Material: Brass

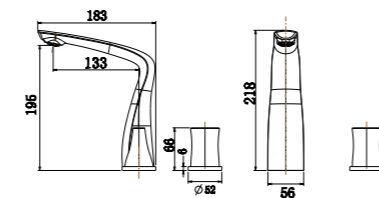
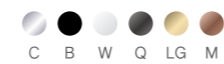

ART

The product is changing,
and the pursuit of beauty remains
unchanged.



20131

单把入墙面盆龙头
Single handle basin faucet

主体材质：铜 / Material: Brass

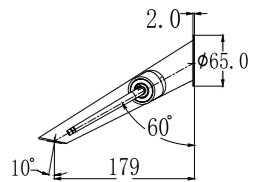

20122

单把面盆龙头
Single handle basin faucet

主体材质：铜 / Material: Brass

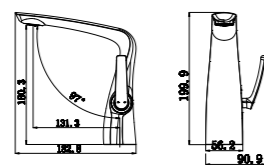

20123

单把分体面盆龙头
Single handle basin faucet

主体材质：铜 / Material: Brass

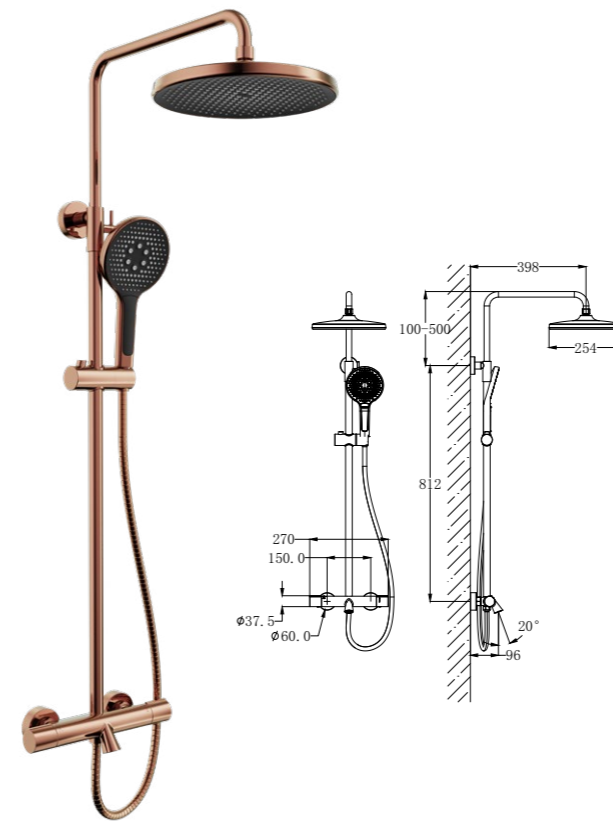
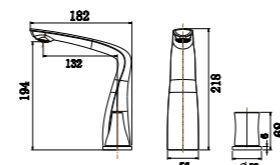

20133

三功能明装淋浴花洒
3-Functional shower set

主体材质：铜 / Material: Brass



20132

单把面盆龙头
Single handle basin faucet

主体材质：铜 / Material: Brass

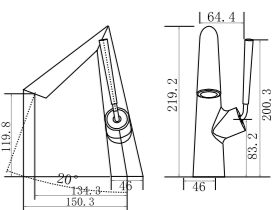
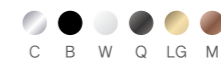



20141

单把面盆龙头
Single handle basin faucet
主体材质：铜 /Material: Brass

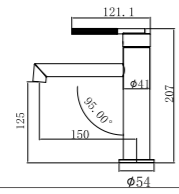

20142

单把面盆龙头
Single handle basin faucet
主体材质：铜 /Material: Brass

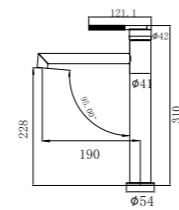

20143

单把入墙面盆龙头
Single handle basin faucet
主体材质：铜 /Material: Brass

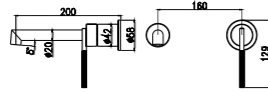

20144

单把入墙面盆龙头
Single handle basin faucet
主体材质：铜 /Material: Brass

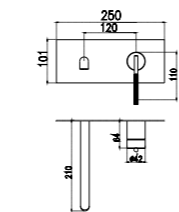

20145

单把厨房龙头
Single handle kitchen mixer
主体材质：铜 /Material: Brass

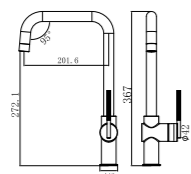

20146

单把分体面盆龙头
Single handle basin faucet
主体材质：铜 /Material: Brass

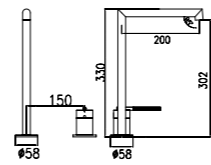

20147

二功能暗装花洒
2-Function In-wall Shower
主体材质：铜 /Material: Brass

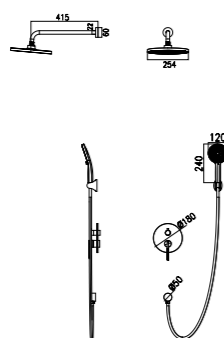

20148

三功能暗装花洒
3-Function In-wall Shower
主体材质：铜 /Material: Brass

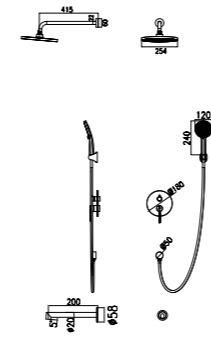

20149

单把淋浴龙头
Single handle shower faucet
主体材质：铜 /Material: Brass

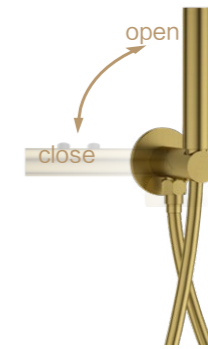
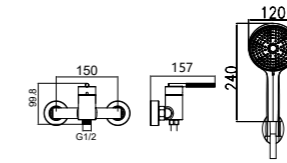

20150

淋浴龙头
Shower faucet
主体材质：铜 /Material: Brass

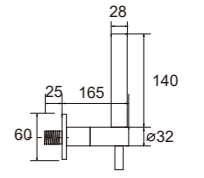

20151

暗装浴缸龙头
IN WALL Bathtub Faucet
主体材质：铜 /Material: Brass

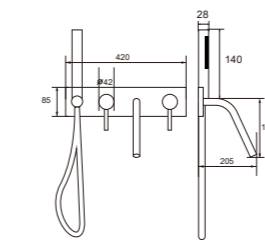

20152

暗装浴缸龙头
IN WALL Bathtub Faucet
主体材质：铜 /Material: Brass

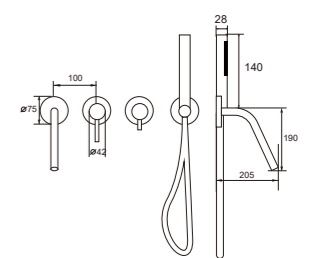



20161
单把面盆龙头
Single handle basin faucet
主体材质: 铜 /Material: Brass

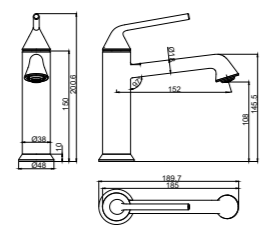

20162
单把面盆龙头
Single handle basin faucet
主体材质: 铜 /Material: Brass

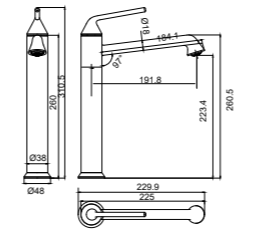

20163
单把浴缸龙头
Single handle Bathtub Faucet
主体材质: 铜 /Material: Brass

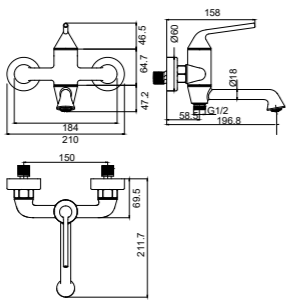

20164
单把淋浴龙头
Single handle shower faucet
主体材质: 铜 /Material: Brass

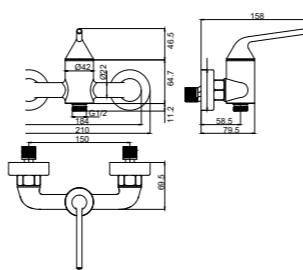

ART

The product is changing,
and the pursuit of beauty remains unchanged.



20165
单把厨房龙头
Single handle kitchen mixer
主体材质: 铜 /Material: Brass

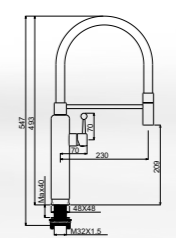

20166
单把面盆龙头
Single handle basin faucet
主体材质: 铜 /Material: Brass

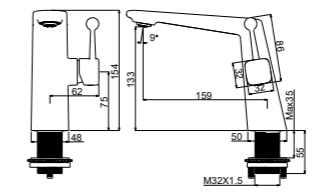

20167
单把厨房龙头
Single handle kitchen mixer
主体材质: 铜 /Material: Brass

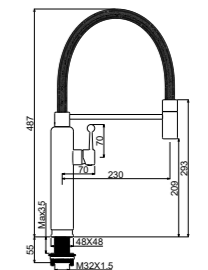

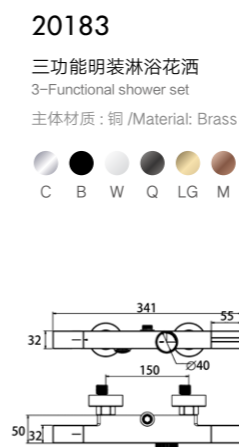
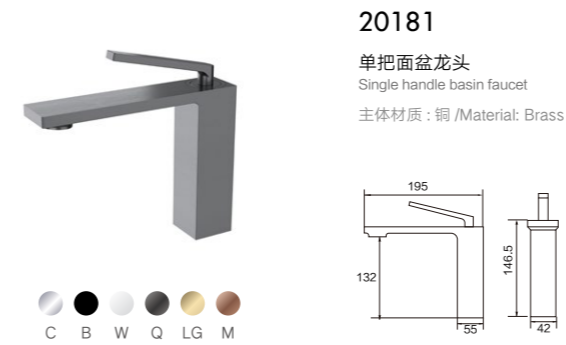
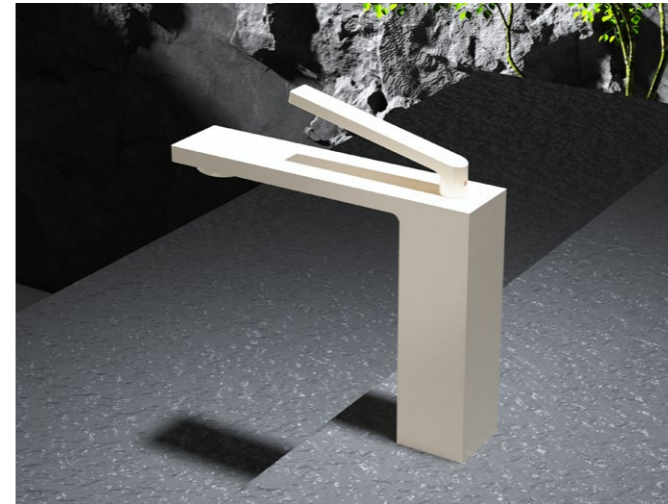

20191

单把面盆龙头

Single handle basin faucet

主体材质: 铜 /Material: Brass

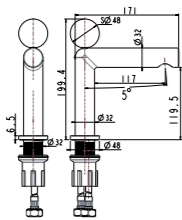

20192

单把面盆龙头

Single handle basin faucet

主体材质: 铜 /Material: Brass

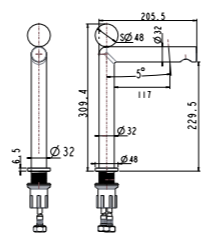

20193

单把浴缸龙头

Single handle Bathtub Faucet

主体材质: 铜 /Material: Brass

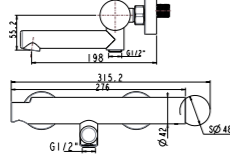

20194

单把淋浴龙头

Single handle shower faucet

主体材质: 铜 /Material: Brass

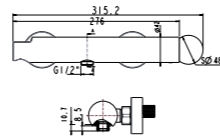

20195 (可选数显 / 触摸感应)

单把抽拉厨房龙头

Pull-out kitchen mixer

主体材质: 铜 /Material: Brass

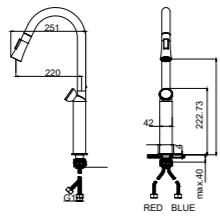

20196

单把抽拉厨房龙头

Pull-out kitchen mixer

主体材质: 铜 /Material: Brass

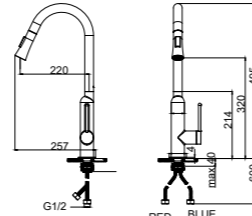
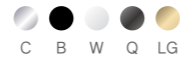

20197

单把面盆龙头

Single handle basin faucet

主体材质: 铜 /Material: Brass

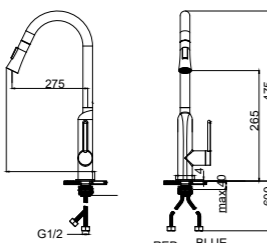

20198

单把抽拉厨房龙头

Pull-out kitchen mixer

主体材质: 铜 /Material: Brass

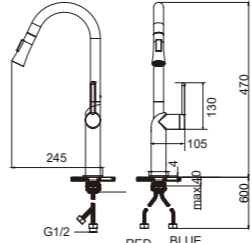

20201

单把面盆龙头

Single handle basin faucet

主体材质: 铜 /Material: Brass

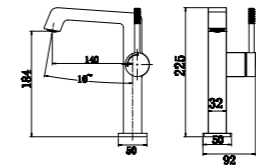

20202

单把面盆龙头

Single handle basin faucet

主体材质: 铜 /Material: Brass

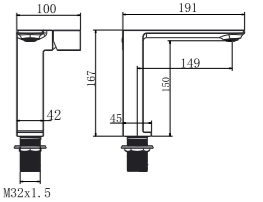

20203

单把面盆龙头

Single handle basin faucet

主体材质: 铜 /Material: Brass

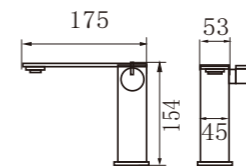

20204

单把面盆龙头

Single handle basin faucet

主体材质: 铜 /Material: Brass

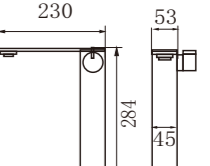





20215
单把浴缸龙头
Single handle Bathtub Faucet
主体材质: 铜 /Material: Brass

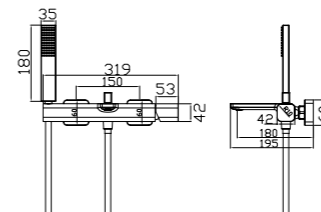

C W Q



20216
单把淋浴龙头
Single handle shower faucet
主体材质: 铜 /Material: Brass

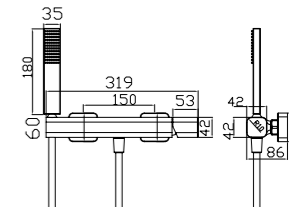

C W Q

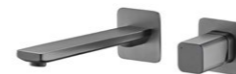

20217
单把入墙面盆龙头
Single handle basin faucet
主体材质: 铜 /Material: Brass

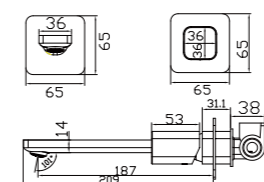

C W Q LG



20218
入墙浴缸龙头
In-wall Bathtub Faucet
主体材质: 铜 /Material: Brass

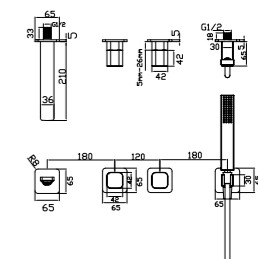

C W Q



20211
单把面盆龙头 (感应皂液器)
Single handle basin faucet
主体材质: 铜 /Material: Brass

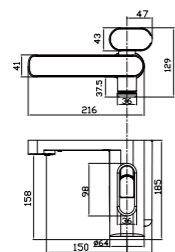

W Q



20212
单把面盆龙头
Single handle basin faucet
主体材质: 铜 /Material: Brass

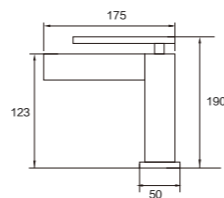

N Q M



20213
单把面盆龙头
Single handle basin faucet
主体材质: 铜 /Material: Brass

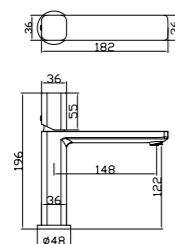

C B W Q LG M



20214
单把面盆龙头
Single handle basin faucet
主体材质: 铜 /Material: Brass

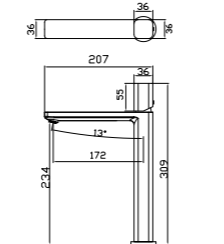

C B W Q LG M

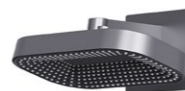

20219
二功能暗装花洒
2-Function In-wall Shower
主体材质: 铜 /Material: Brass

C W Q

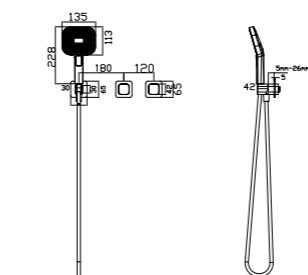

20220
三功能明装花洒
3-Function Shower set
主体材质: 铜 /Material: Brass

C W Q

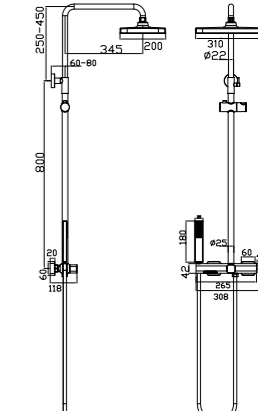



20222
单把面盆龙头
Single handle basin faucet
主体材质：铜 /Material: Brass

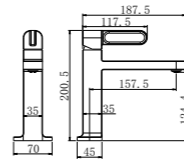

20223
升降抽拉面盆龙头
Pull-out basin faucet
主体材质：铜 /Material: Brass

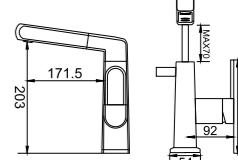

20224
单把抽拉厨房龙头
Pull-out kitchen mixer
主体材质：铜 /Material: Brass

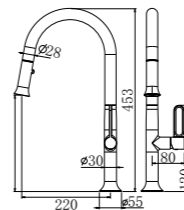

20225
单把抽拉厨房龙头
Pull-out kitchen mixer
主体材质：铜 /Material: Brass

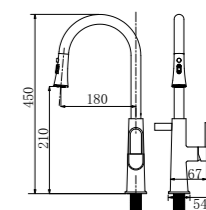

20221
单把抽拉面盆龙头
Pull-out basin faucet
主体材质：铜 /Material: Brass

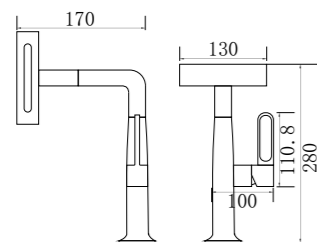

4 function

4 种模式

The sculpted silhouette paired with smooth surfaces and textured patterns creates a charming collection that enriches private living spaces with beautiful, well crafted, and reliable items.



20226
三功能明装花洒
3-Function Shower set
主体材质：铜 /Material: Brass

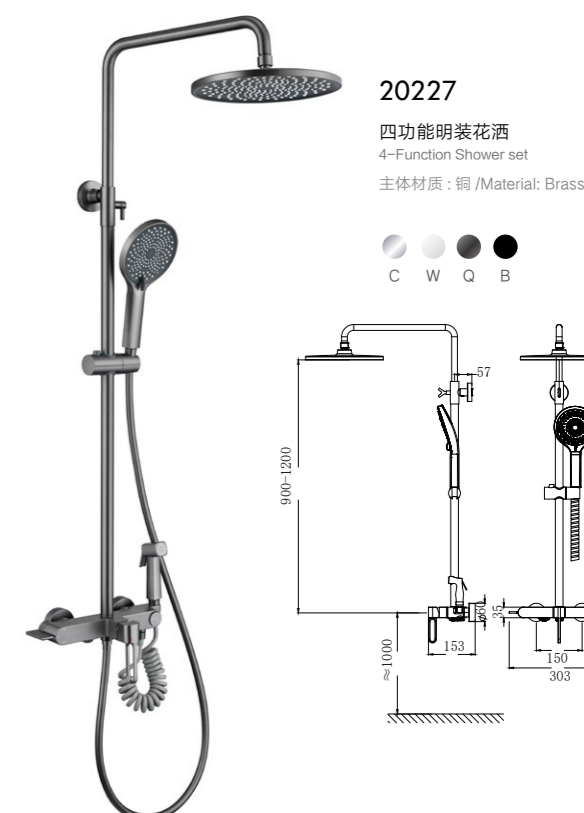
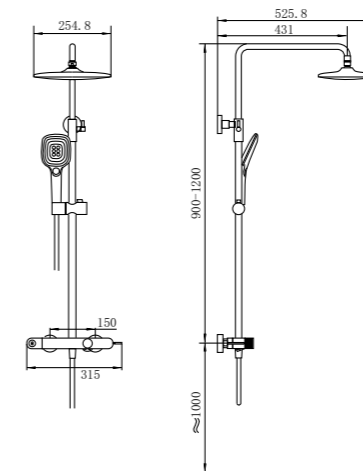

20227
四功能明装花洒
4-Function Shower set
主体材质：铜 /Material: Brass

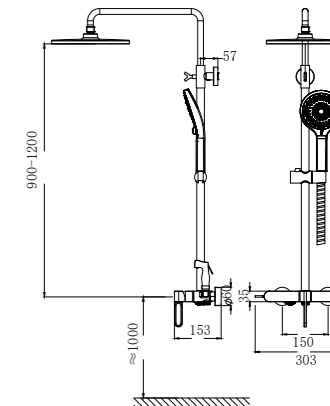



20231
单把面盆龙头
Single handle basin faucet
主体材质: 铜 /Material: Brass

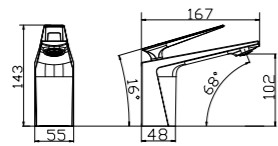

20232
单把面盆龙头
Single handle basin faucet
主体材质: 铜 /Material: Brass

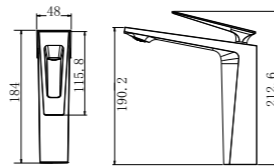

20241
单把面盆龙头
Single handle basin faucet
主体材质: 铜 /Material: Brass

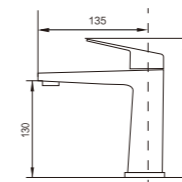

20242
升降抽拉面盆龙头
Pull-out basin faucet
主体材质: 铜 /Material: Brass

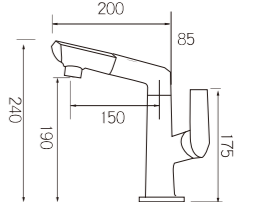

20233
单把抽拉厨房龙头
Pull-out kitchen mixer
主体材质: 铜 /Material: Brass

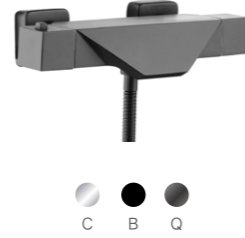
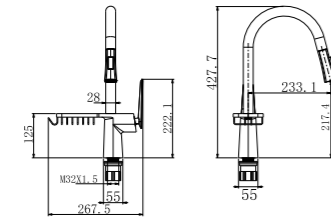

20234
浴缸龙头
Bathtub Faucet
主体材质: 铜 /Material: Brass

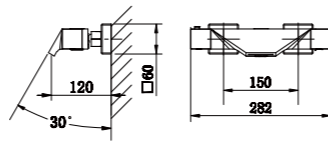

20243
单把入墙面盆龙头
Single handle basin faucet
主体材质: 铜 /Material: Brass

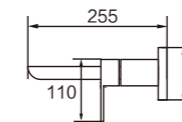

20244
单把抽拉厨房龙头
Pull-out kitchen mixer
主体材质: 铜 /Material: Brass

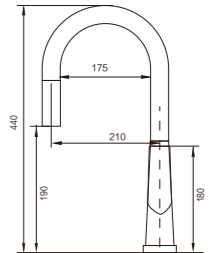

20235
三功能明装花洒
3-Function Shower set
主体材质: 铜 /Material: Brass

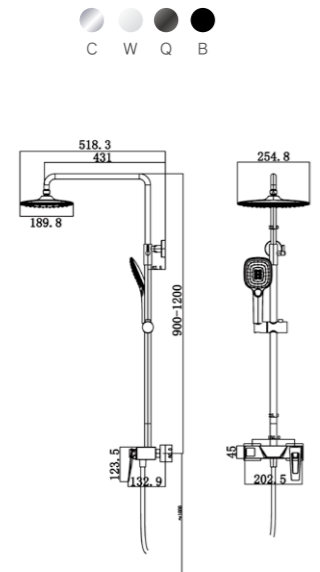

20236
三功能明装花洒
3-Function Shower set
主体材质: 铜 /Material: Brass

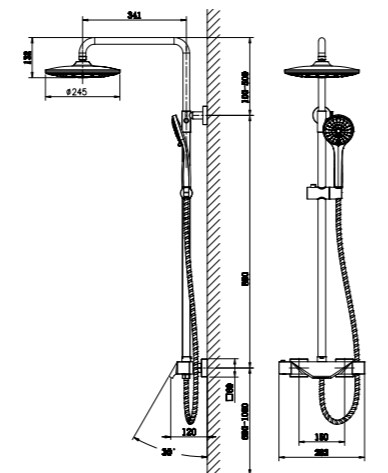

20245
三功能明装花洒
3-Function Shower set
主体材质: 铜 /Material: Brass

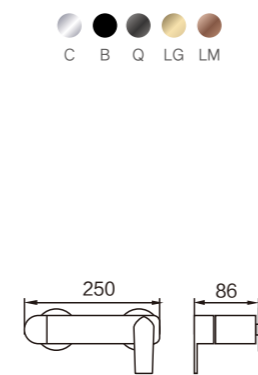

20246
二功能简易花洒
2-Function Simple Shower
主体材质: 铜 /Material: Brass

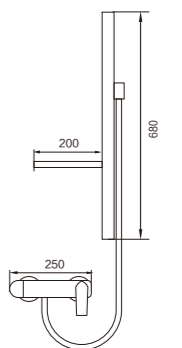



20261

单把面盆龙头

Single handle basin faucet
主体材质: 铜 /Material: Brass

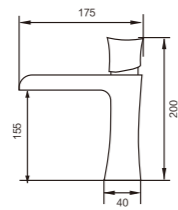

20262

单把面盆龙头

Single handle basin faucet
主体材质: 铜 /Material: Brass

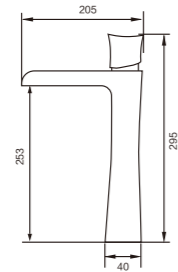

20263

单把厨房龙头

Single handle kitchen mixer
主体材质: 铜 /Material: Brass

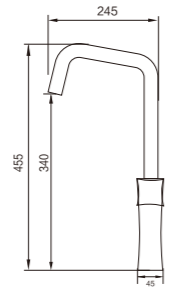

20264

单把浴缸龙头

Single handle Bathtub Faucet
主体材质: 铜 /Material: Brass

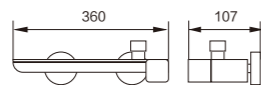

20265

三功能明装花洒

3-Function Shower set
主体材质: 铜 /Material: Brass

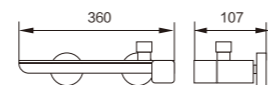

20271

单把面盆龙头

Single handle basin faucet
主体材质: 铜 /Material: Brass

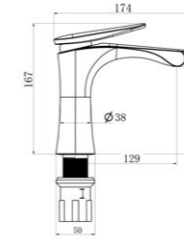

20272

单把面盆龙头

Single handle basin faucet
主体材质: 铜 /Material: Brass

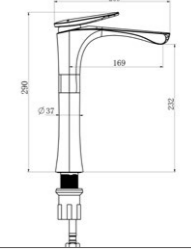

20273

单把厨房龙头

Single handle kitchen mixer
主体材质: 铜 /Material: Brass

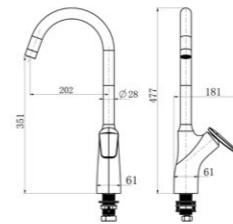

20274

单把浴缸龙头

Single handle Bathtub Faucet
主体材质: 铜 /Material: Brass

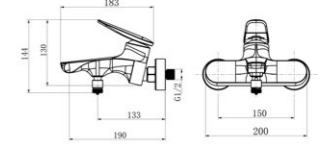

20275

三功能明装花洒

3-Function Shower set
主体材质: 铜 /Material: Brass

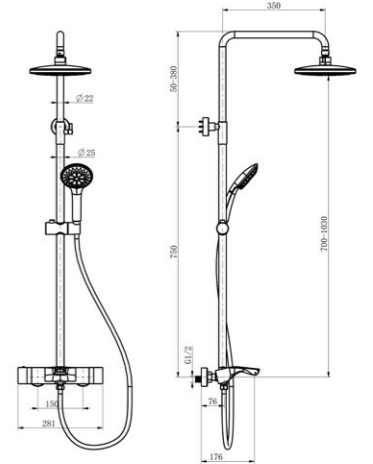



20281

单把面盆龙头
Single handle basin faucet
主体材质: 铜 /Material: Brass

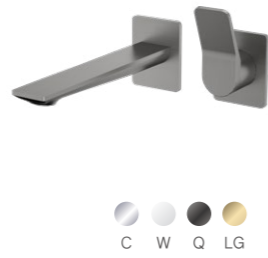
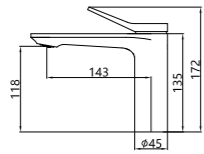

20282

单把入墙面盆龙头
In-wall basin faucet
主体材质: 铜 /Material: Brass

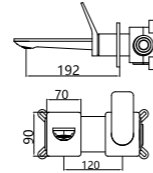

20283

单把面盆龙头
Single handle basin faucet
主体材质: 铜 /Material: Brass

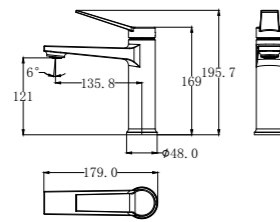

20284

单把抽拉面盆龙头
Pull-out basin faucet
主体材质: 铜 /Material: Brass

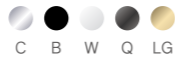
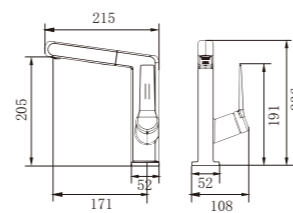

20285

二功能暗装花洒
3-Function In-wall Shower
主体材质: 铜 /Material: Brass

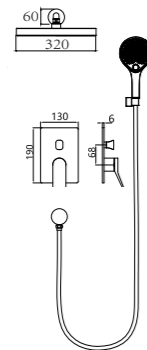

20286

三功能明装花洒
3-Function Shower set
主体材质: 铜 /Material: Brass

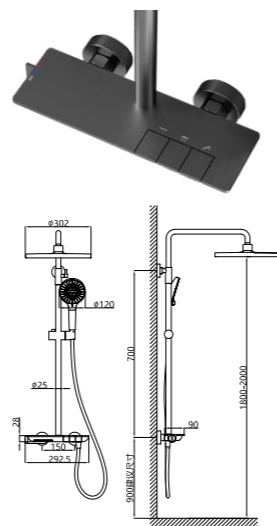

20291

单把面盆龙头
Single handle basin faucet
主体材质: 铜 /Material: Brass

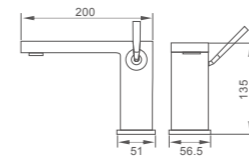

20292

单把面盆龙头
Single handle basin faucet
主体材质: 铜 /Material: Brass

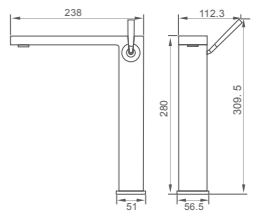

20293

三功能明装花洒
3-Function Shower set
主体材质: 铜 /Material: Brass



20294

三功能明装花洒
3-Function Shower set
主体材质: 铜 /Material: Brass

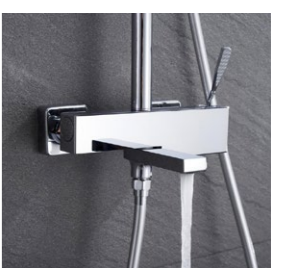



20301

单把面盆龙头
Single handle basin faucet
主体材质: 铜 /Material: Brass

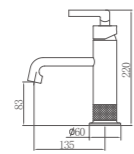

20302

单把面盆龙头
Single handle basin faucet
主体材质: 铜 /Material: Brass

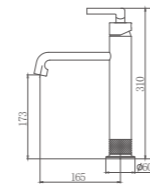

20303

入墙面盆龙头
In-wall basin faucet
主体材质: 铜 /Material: Brass

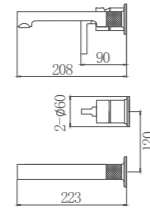

20304

入墙面盆龙头
In-wall basin faucet
主体材质: 铜 /Material: Brass

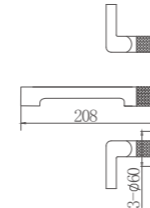

20305

入墙面盆龙头
In-wall basin faucet
主体材质: 铜 /Material: Brass

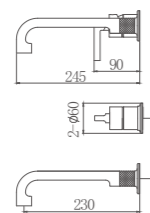

20306

入墙面盆龙头
In-wall basin faucet
主体材质: 铜 /Material: Brass

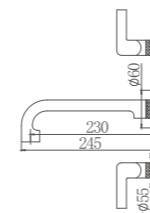

20307

单把分体面盆龙头
Single handle basin faucet
主体材质: 铜 /Material: Brass

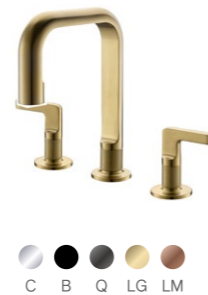
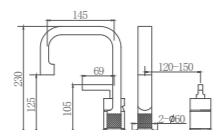

20308

双把分体面盆龙头
Single handle basin faucet
主体材质: 铜 /Material: Brass

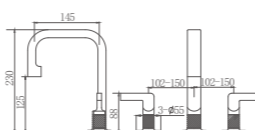

PRIVATE LIVING SPACES

20309

落地浴缸龙头
Free Standing Bathtub Faucet
主体材质: 铜 /Material: Brass

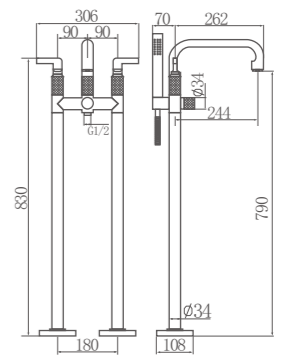

20310

分体浴缸龙头
Single handle Bathtub Faucet
主体材质: 铜 /Material: Brass

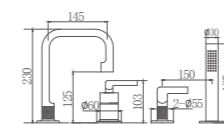

20312

二功能暗装花洒
2-Function In-wall Shower
主体材质: 铜 /Material: Brass

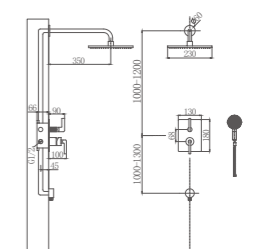

20311

分体浴缸龙头
Single handle Bathtub Faucet
主体材质: 铜 /Material: Brass

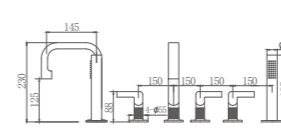



20321

单把面盆龙头
Single handle basin faucet
主体材质: 铜 /Material: Brass

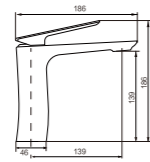

20323

三功能明装花洒
3-Function Shower set
主体材质: 铜 /Material: Brass

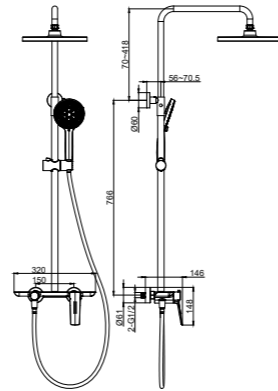

20341

单把面盆龙头
Single handle basin faucet
主体材质: 铜 /Material: Brass

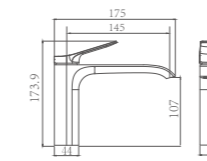

20342

单把面盆龙头
Single handle basin faucet
主体材质: 铜 /Material: Brass

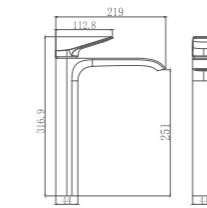

20322

单把浴缸龙头
Single handle Bathtub Faucet
主体材质: 铜 /Material: Brass

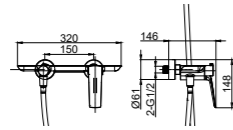

20331

单把面盆龙头
Single handle basin faucet
主体材质: 铜 /Material: Brass

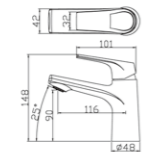

20333

三功能明装花洒
3-Function Shower set
主体材质: 铜 /Material: Brass

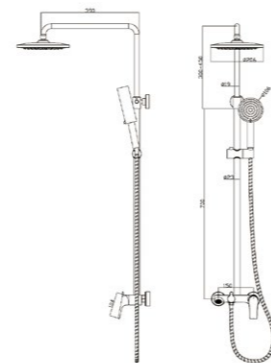

20343

三功能明装花洒
3-Function Shower set
主体材质: 铜 /Material: Brass

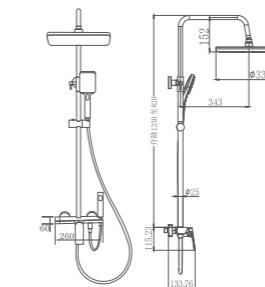

20344

三功能明装花洒
3-Function Shower set
主体材质: 铜 /Material: Brass

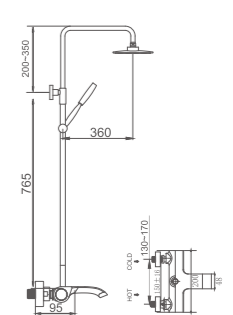

20332

单把浴缸龙头
Single handle Bathtub Faucet
主体材质: 铜 /Material: Brass

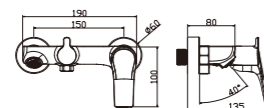



C B Q LG

20351

单把面盆龙头
Single handle basin faucet
主体材质: 铜 /Material: Brass

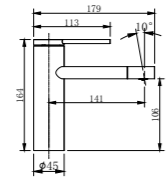

C B Q LG

20352

单把面盆龙头
Single handle basin faucet
主体材质: 铜 /Material: Brass

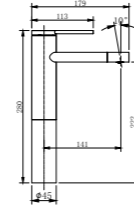

C B Q LG

20353

单把厨房龙头
Single handle kitchen mixer
主体材质: 铜 /Material: Brass

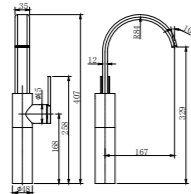

C B Q LG

20354

单把浴缸龙头
Single handle Bathtub Faucet
主体材质: 铜 /Material: Brass

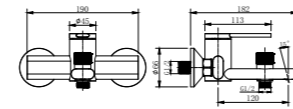

20355

二功能明装花洒
2-Function Shower set
主体材质: 铜 /Material: Brass

C B Q LG

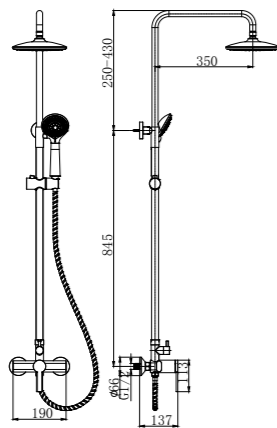

20356

三功能明装花洒
3-Function Shower set
主体材质: 铜 /Material: Brass

C B Q LG

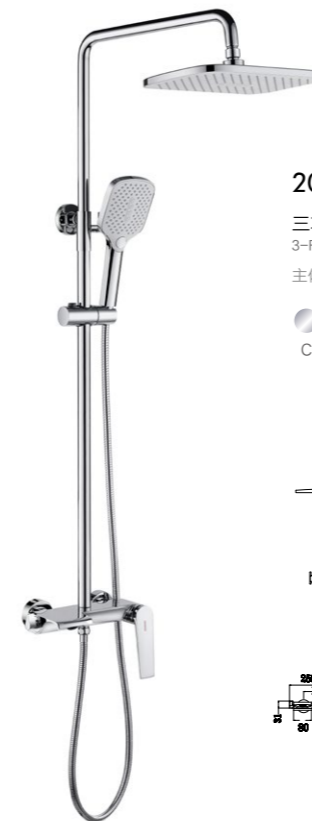
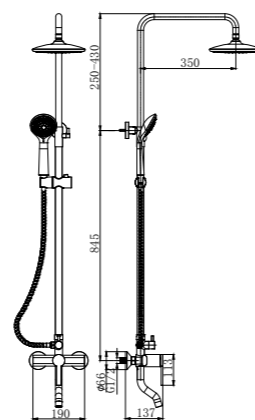

20361

三功能明装花洒
3-Function Shower set
主体材质: 铜 /Material: Brass

C B Q

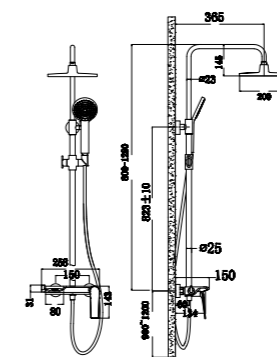

C B Q

20362

单把面盆龙头
Single handle basin faucet
主体材质: 铜 /Material: Brass

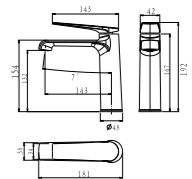

C B Q

20363

单把面盆龙头
Single handle basin faucet
主体材质: 铜 /Material: Brass

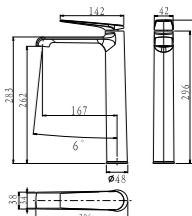



C B W Q LG M

20371

单把面盆龙头
Single handle basin faucet
主体材质: 铜 /Material: Brass

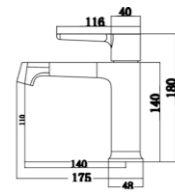

C B W Q LG M

20372

单把面盆龙头
Single handle basin faucet
主体材质: 铜 /Material: Brass

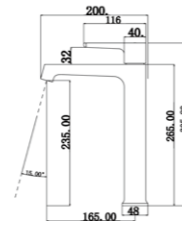

C B W Q LG M

20373

入墙面盆龙头
In-wall basin faucet
主体材质: 铜 /Material: Brass

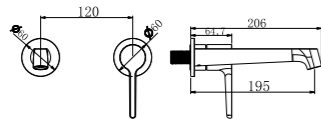

C B W Q LG M

20374

入墙面盆龙头
In-wall basin faucet
主体材质: 铜 /Material: Brass

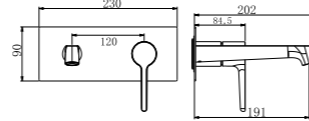

20375

三功能明装花洒
3-Function Shower set
主体材质: 铜 /Material: Brass

C B W Q LG M

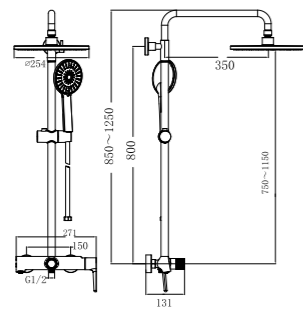

C B W Q LG M

20376

三功能暗装花洒
3-Function In-wall Shower
主体材质: 铜 /Material: Brass

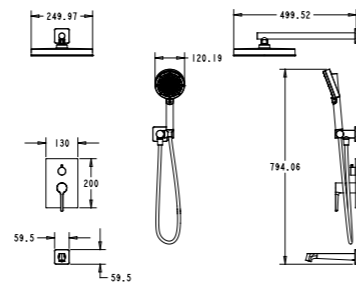

20381

入墙面盆龙头
In-wall basin faucet
主体材质: 铜 /Material: Brass

C B Q LG LM



20382

入墙面盆龙头
In-wall basin faucet
主体材质: 铜 /Material: Brass

C B Q LG LM



20383

单把分体面盆龙头
Single handle basin faucet
主体材质: 铜 /Material: Brass

C B Q LG LM



20384

双把分体面盆龙头
Single handle basin faucet
主体材质: 铜 /Material: Brass

C B Q LG LM



20385

分体立柱面盆龙头
Split column basin faucet
主体材质: 铜 /Material: Brass

C B Q LG LM



20386

二功能暗装花洒
2-Function In-wall Shower
主体材质: 铜 /Material: Brass

C B Q LG LM

CONCEALED SHOWER SET

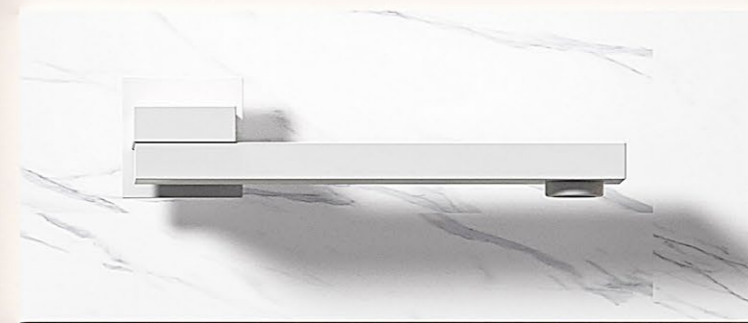

如光，肆意舞动，当心放空，顷刻闭眼倾听，轻声细语，优雅从容透过光芒，张扬又深邃，沉静又动感，彰显极致经典魅力

Such as light, wanton dance, take care to empty, instantly close your eyes to listen, quietly whisper, elegant calm, through the light, publicity and profound, quiet and dynamic, highlighting the ultimate classic charm





Concealed

SHOWER SET

四功能恒温暗装淋浴花洒
4F constant temperature concealed shower

主体材质: 铜 / Material: Brass

C B W Q LG M

590x590

130 130 270 87 442

淋浴 瀑布

1200mm

淋浴网预埋底部到瓷砖面深度为: 90-100mm

毛坯面开孔尺寸: 105mm 420mm

● 热水 ● 冷水 ● 混合水

21001 数显

21002 非数显

注: 产品需要在专业人士指导下安装

三功能恒温暗装淋浴花洒
3F constant temperature concealed shower

主体材质: 铜 / Material: Brass

C B W Q LG M

Ø320

130 270 87 400

淋浴 瀑布

2200mm

1200mm

淋浴网预埋底部到瓷砖面深度为: 90-100mm

毛坯面开孔尺寸: 105mm 420mm

● 热水 ● 冷水 ● 混合水

21003 数显

21004 非数显



21005
三功能恒温暗装淋浴花洒
3F constanttemperature concealed shower
主体材质: 铜 /Material: Brass

颜色选项: C B W Q LG M



顶喷预埋盒预埋到瓷砖面深度为: 70-80mm

淋浴花洒预埋底部到瓷砖面深度为: 90-100mm

毛胚面开孔尺寸: 10mm x 220mm

● 热水 ● 冷水 ● 混合水



21006
二功能恒温暗装淋浴花洒
2F constanttemperature concealed shower
主体材质: 铜 /Material: Brass



21007
三功能恒温暗装淋浴花洒
3F constanttemperature concealed shower
主体材质: 铜 /Material: Brass

颜色选项: C B W Q LG M

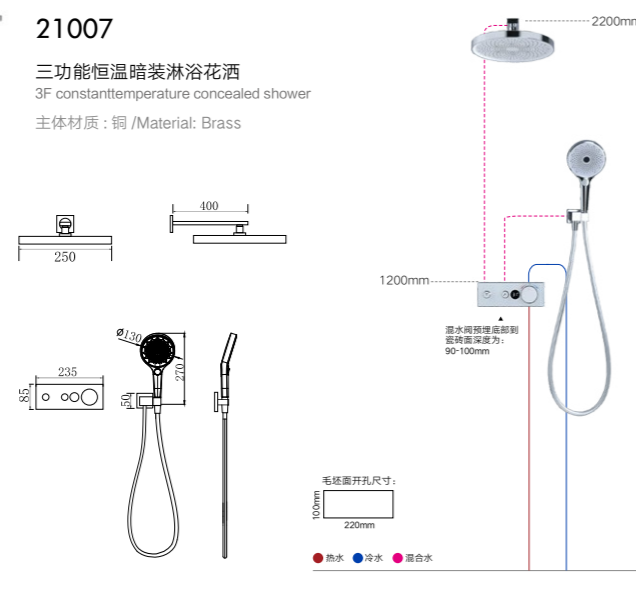

顶喷预埋盒预埋到瓷砖面深度为: 70-80mm

淋浴花洒预埋底部到瓷砖面深度为: 90-100mm

毛胚面开孔尺寸: 10mm x 220mm

● 热水 ● 冷水 ● 混合水



21008
二功能恒温暗装淋浴花洒
2F constanttemperature concealed shower
主体材质: 铜 /Material: Brass



21009
三功能恒温暗装淋浴花洒
3F constanttemperature concealed shower
主体材质: 铜 /Material: Brass

颜色选项: C B W Q LG M



顶喷预埋盒预埋到瓷砖面深度为: 70-80mm

淋浴花洒预埋底部到瓷砖面深度为: 90-100mm

毛胚面开孔尺寸: 10mm x 420mm

● 热水 ● 冷水 ● 混合水



21010
四功能恒温暗装淋浴花洒
4F constanttemperature concealed shower
主体材质: 铜 /Material: Brass

颜色选项: C B W Q LG M



21011
三功能恒温暗装淋浴花洒
3F constanttemperature concealed shower
主体材质: 铜 /Material: Brass

颜色选项: C B W Q LG M



顶喷预埋盒预埋到瓷砖面深度为: 70-80mm

淋浴花洒预埋底部到瓷砖面深度为: 90-100mm

毛胚面开孔尺寸: 10mm x 290mm

● 热水 ● 冷水 ● 混合水



21010
四功能恒温暗装淋浴花洒
4F constanttemperature concealed shower
主体材质: 铜 /Material: Brass

颜色选项: C B W Q LG M



21011
三功能恒温暗装淋浴花洒
3F constanttemperature concealed shower
主体材质: 铜 /Material: Brass

颜色选项: C B W Q LG M



顶喷预埋盒预埋到瓷砖面深度为: 70-80mm

淋浴花洒预埋底部到瓷砖面深度为: 90-100mm

毛胚面开孔尺寸: 10mm x 290mm

● 热水 ● 冷水 ● 混合水



21011
三功能恒温暗装淋浴花洒
3F constanttemperature concealed shower
主体材质: 铜 /Material: Brass

颜色选项: C B W Q LG M



4 FUNCTIONS

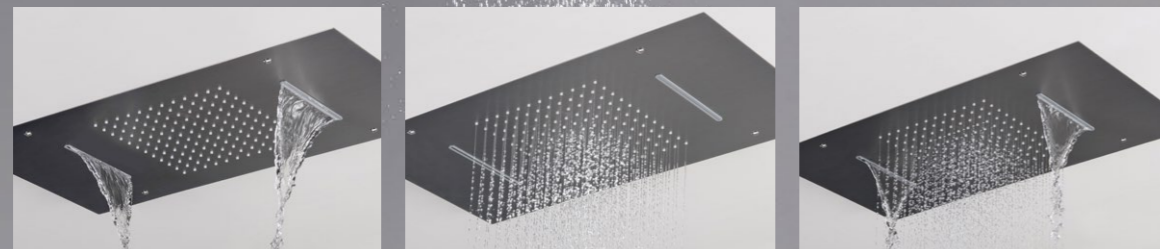

21012

四功能恒温暗装淋浴花洒
4F constant temperature concealed shower

主体材质: 铜 / Material: Brass

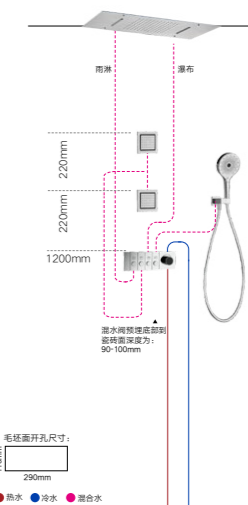
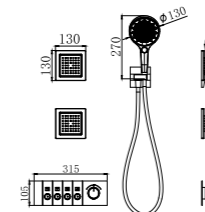

21013

四功能恒温暗装淋浴花洒
4F constant temperature concealed shower

主体材质: 铜 / Material: Brass

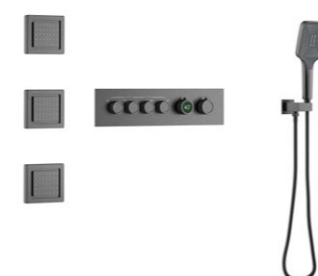
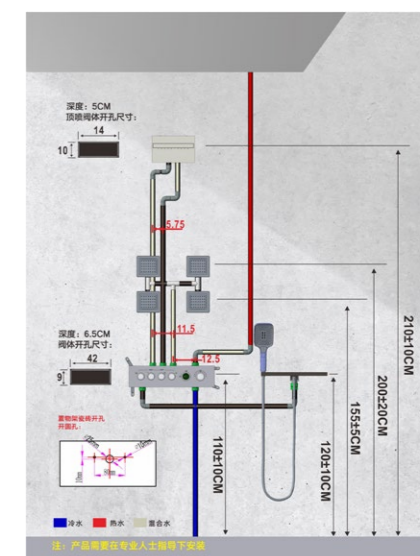
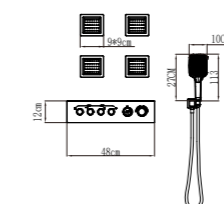
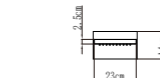

21014

四功能恒温暗装淋浴花洒
4F constant temperature concealed shower

主体材质: 铜 / Material: Brass

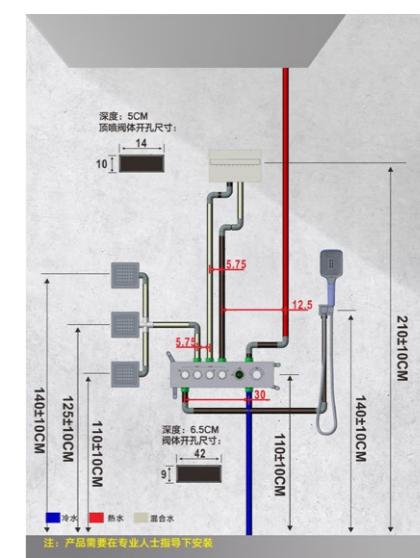
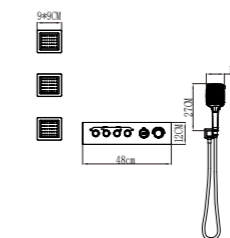
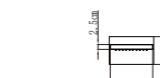



21015
三功能恒温暗装淋浴花洒
3F constant temperature concealed shower
主体材质: 铜 /Material: Brass

C B W Q LG M

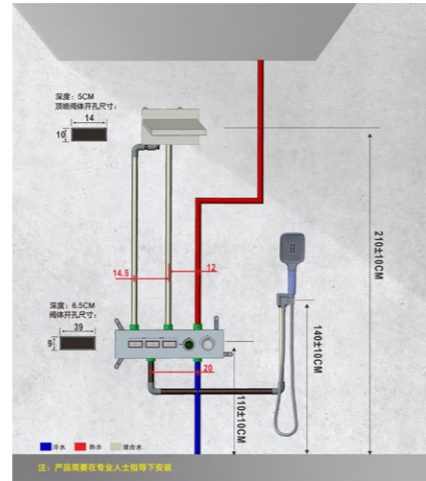

21018
三功能恒温暗装淋浴花洒
3F constant temperature concealed shower
主体材质: 铜 /Material: Brass

C B W Q LG M

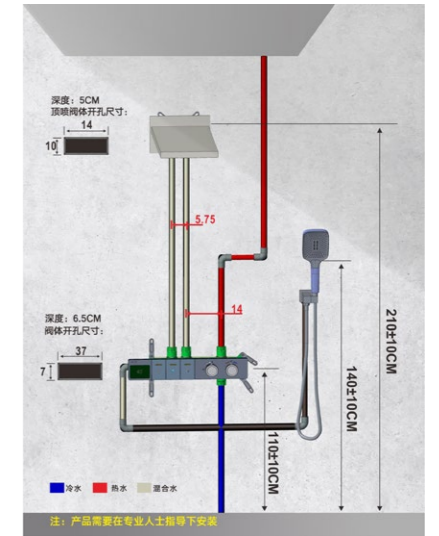

21016
四功能恒温暗装淋浴花洒
4F constant temperature concealed shower
主体材质: 铜 /Material: Brass

C B W Q LG M

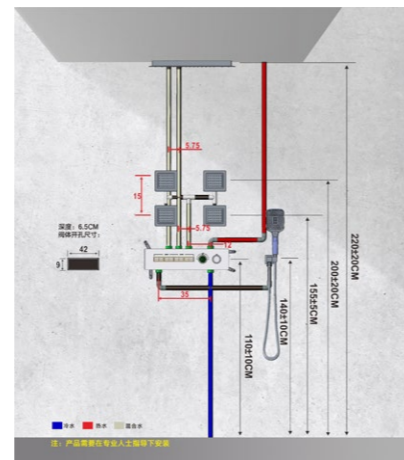

21019
三功能恒温暗装淋浴花洒
3F constant temperature concealed shower
主体材质: 铜 /Material: Brass

C B W Q LG M

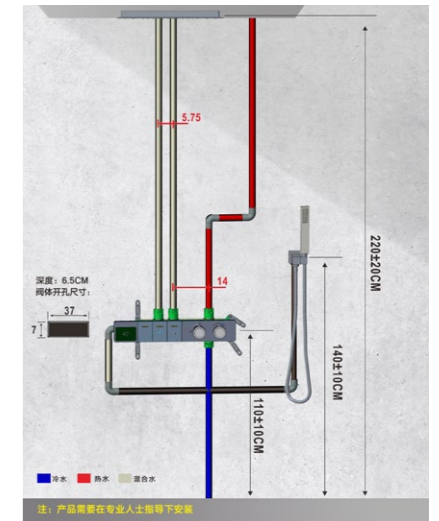

21017
三功能恒温暗装淋浴花洒
3F constant temperature concealed shower
主体材质: 铜 /Material: Brass

C B W Q LG M

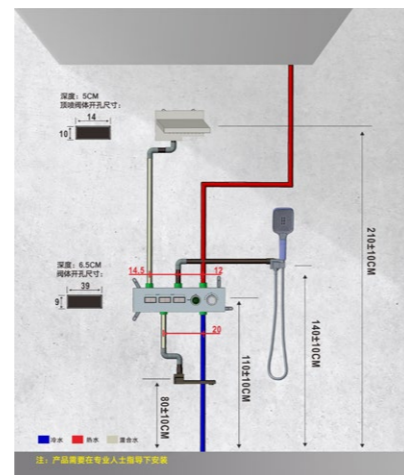

21020
三功能恒温暗装淋浴花洒
3F constant temperature concealed shower
主体材质: 铜 /Material: Brass

C B W Q LG M

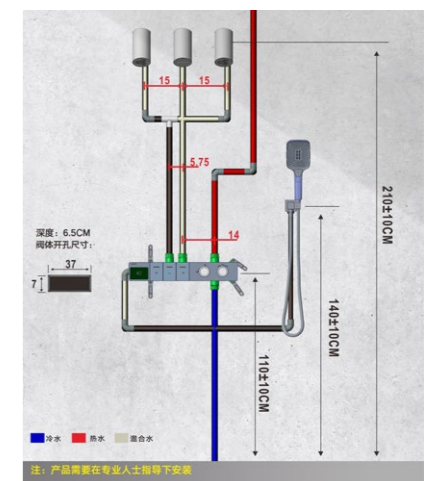



21021
三功能恒温暗装淋浴花洒
3F constant temperature concealed shower

主体材质: 铜 /Material: Brass

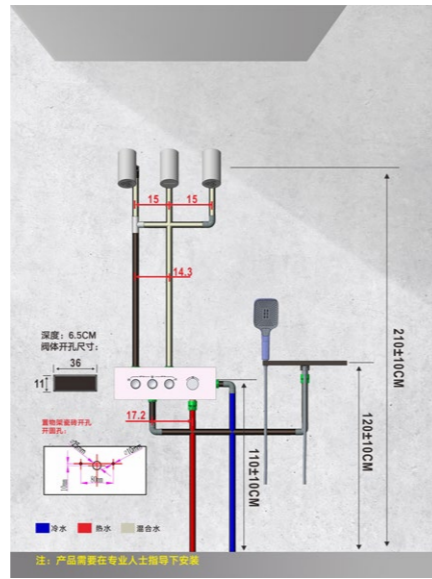
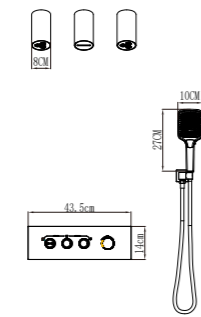

21024
三功能恒温暗装淋浴花洒
3F constant temperature concealed shower

主体材质: 铜 /Material: Brass

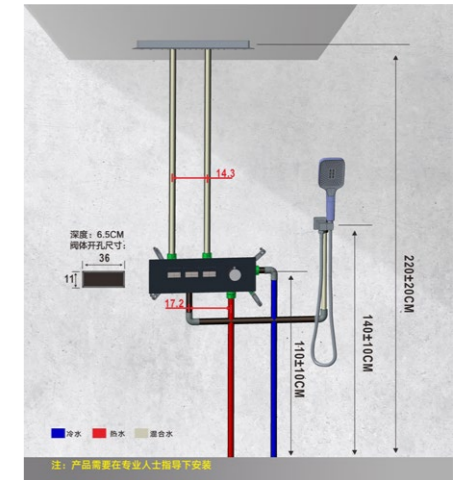
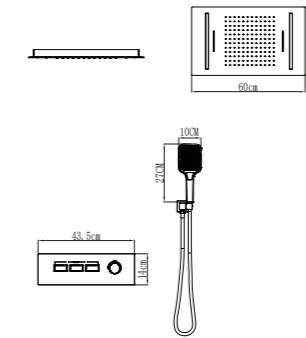

21022
三功能恒温暗装淋浴花洒
3F constant temperature concealed shower

主体材质: 铜 /Material: Brass

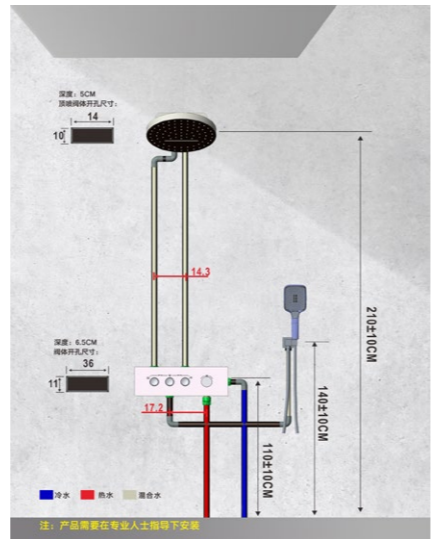
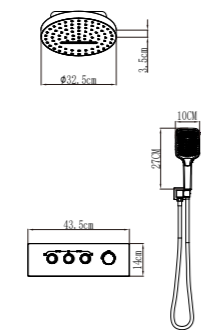

21025
二功能恒温暗装淋浴花洒
2F constant temperature concealed shower

主体材质: 铜 /Material: Brass

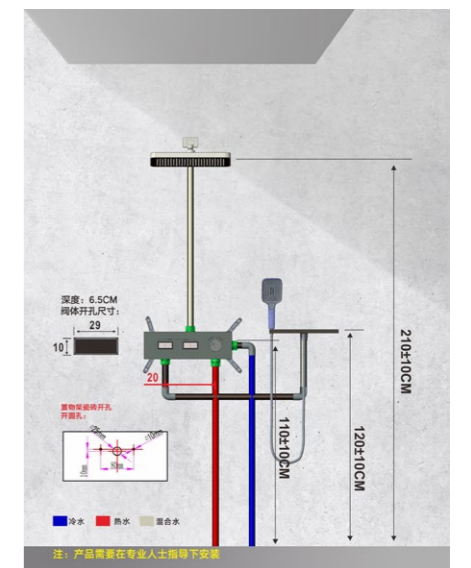
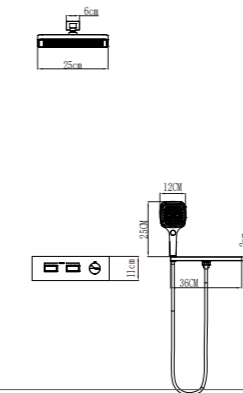

21023
三功能恒温暗装淋浴花洒
3F constant temperature concealed shower

主体材质: 铜 /Material: Brass

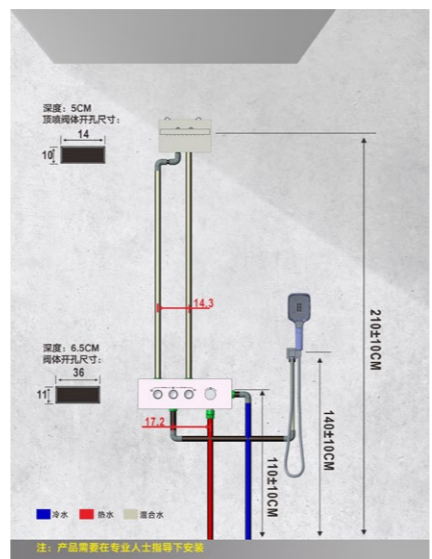
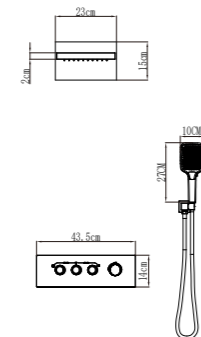

21026
二功能恒温暗装淋浴花洒
2F constant temperature concealed shower

主体材质: 铜 /Material: Brass

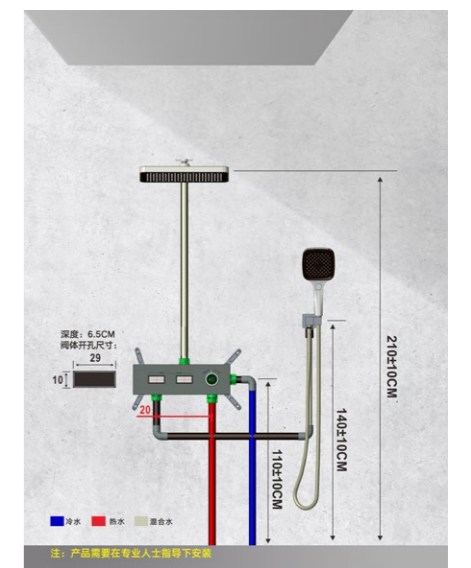
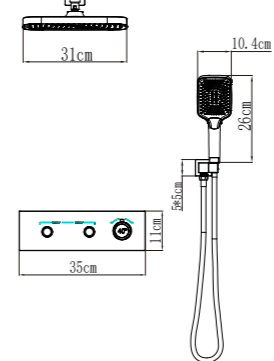



21027
二功能恒温暗装淋浴花洒
2F constant temperature concealed shower
主体材质: 铜 /Material: Brass

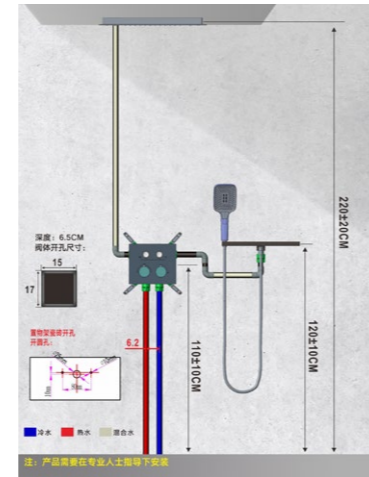
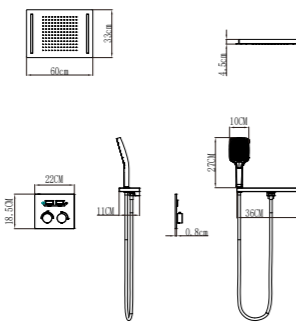

21030
二功能恒温暗装淋浴花洒
2F constant temperature concealed shower
主体材质: 铜 /Material: Brass

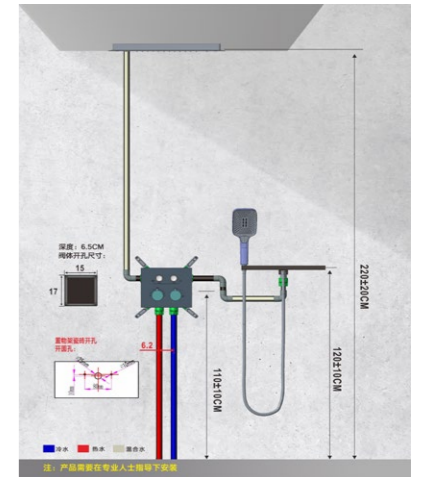
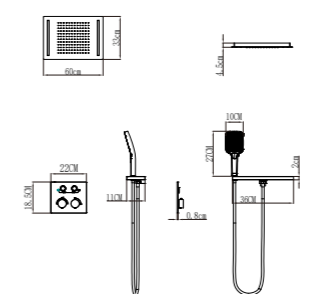

21028
三功能恒温暗装淋浴花洒
3F constant temperature concealed shower
主体材质: 铜 /Material: Brass

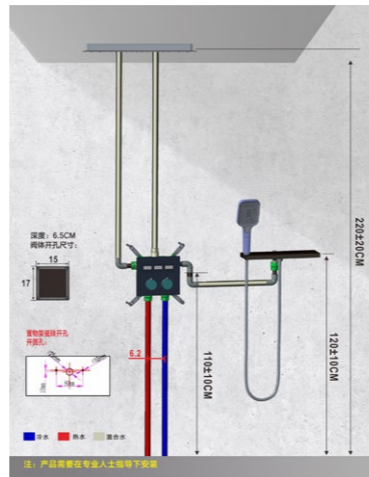
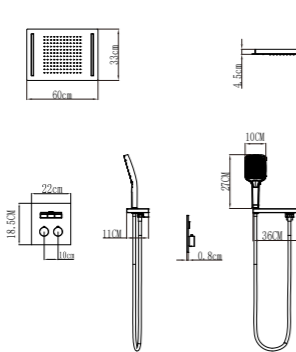

21031
二功能恒温暗装淋浴花洒
2F constant temperature concealed shower
主体材质: 铜 /Material: Brass

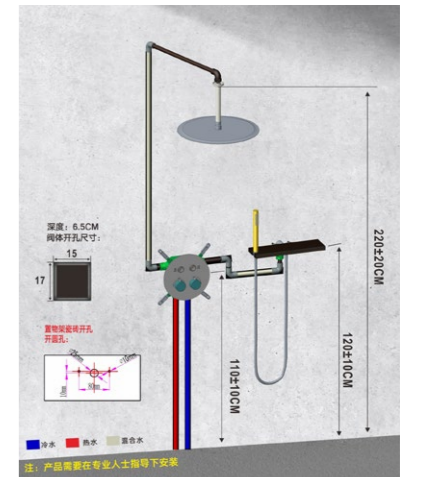
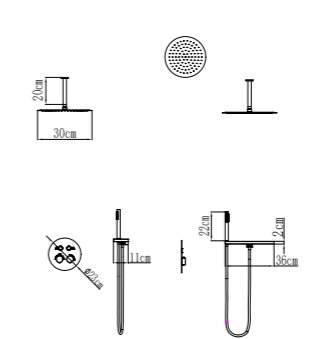

21029
三功能恒温暗装淋浴花洒
3F constant temperature concealed shower
主体材质: 铜 /Material: Brass

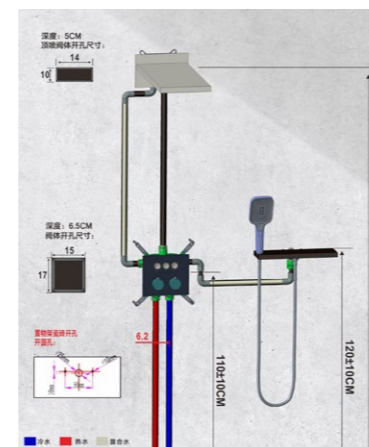
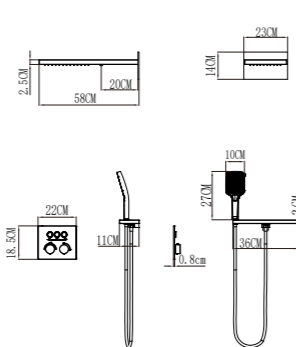

21032
三功能恒温暗装淋浴花洒
3F constant temperature concealed shower
主体材质: 铜 /Material: Brass

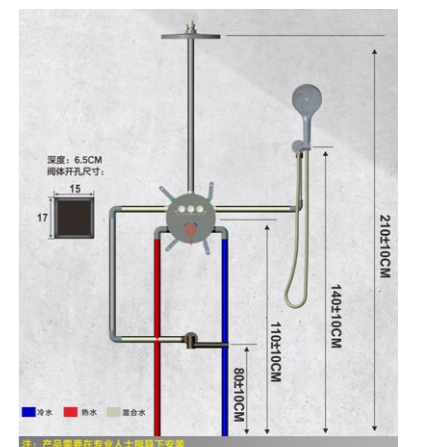
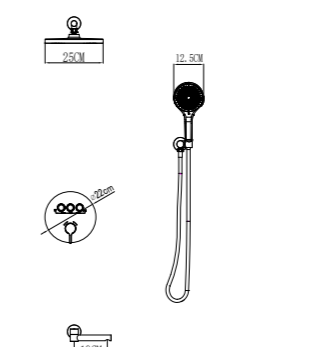



21033
三功能恒温暗装淋浴花洒
3F constant temperature concealed shower
主体材质: 铜 /Material: Brass

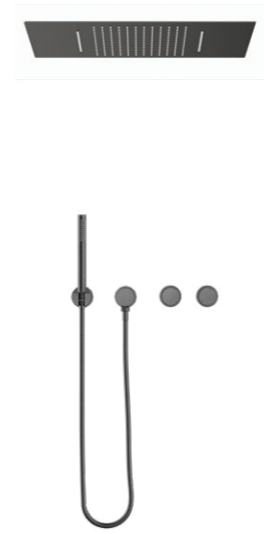
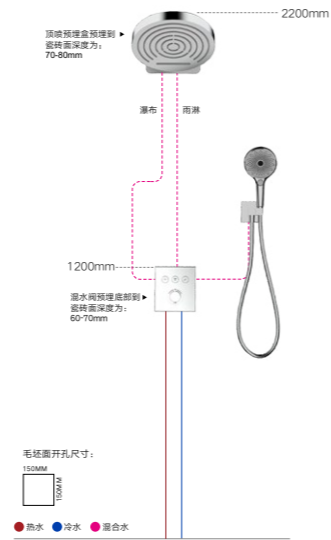
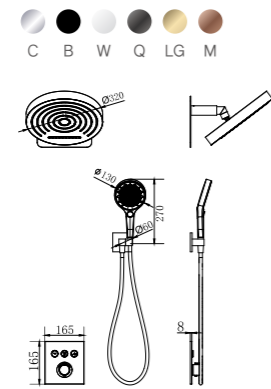

21036
三功能恒温暗装淋浴花洒
3F constant temperature concealed shower
主体材质: 铜 /Material: Brass

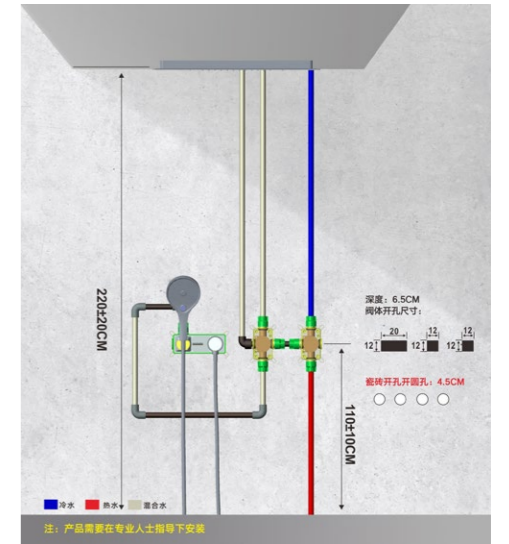
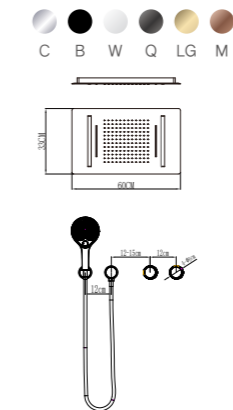

21034
二功能恒温暗装淋浴花洒
2F constant temperature concealed shower
主体材质: 铜 /Material: Brass

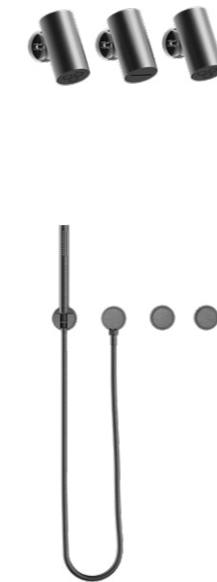
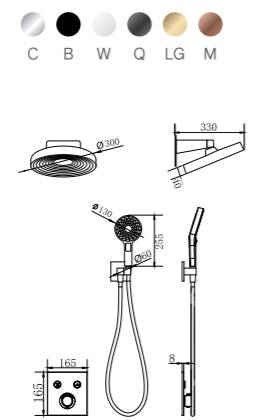

21037
三功能恒温暗装淋浴花洒
3F constant temperature concealed shower
主体材质: 铜 /Material: Brass

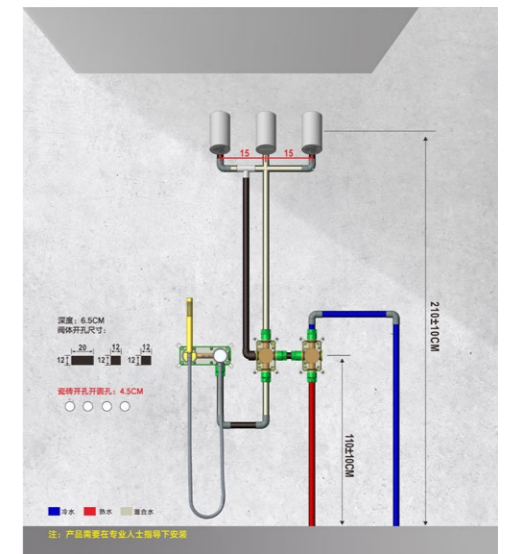
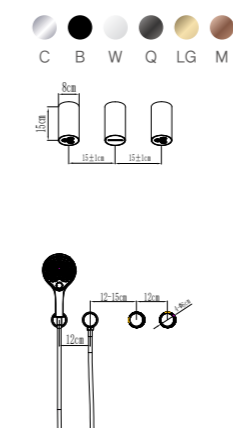

21035
三功能恒温暗装淋浴花洒
3F constant temperature concealed shower
主体材质: 铜 /Material: Brass

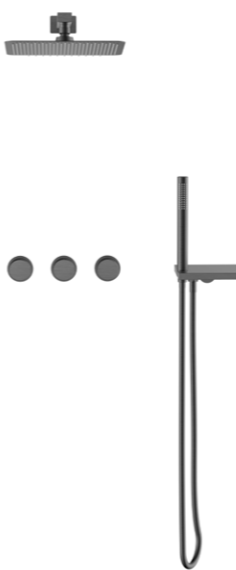
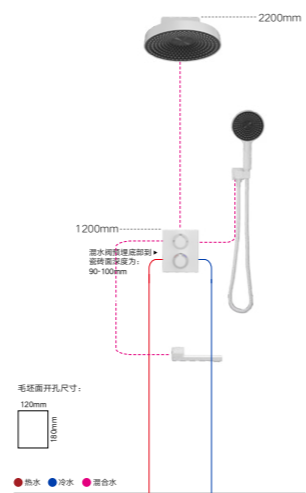
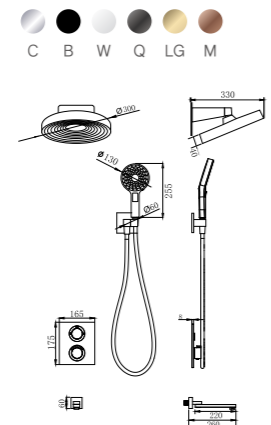

21038
二功能恒温暗装淋浴花洒
2F constant temperature concealed shower
主体材质: 铜 /Material: Brass

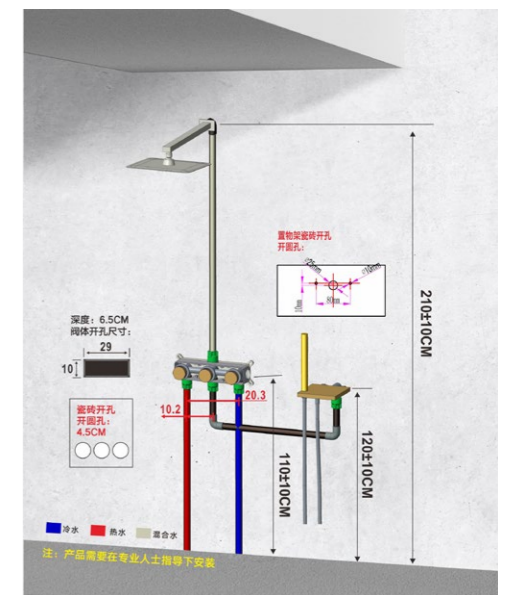
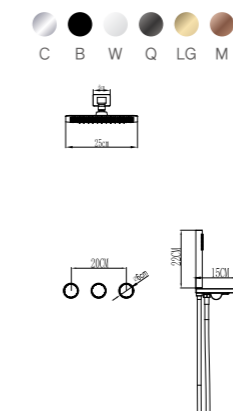



21039
四功能恒温暗装淋浴花洒
4F constant temperature concealed shower
主体材质: 铜 / Material: Brass

C B W Q LG M

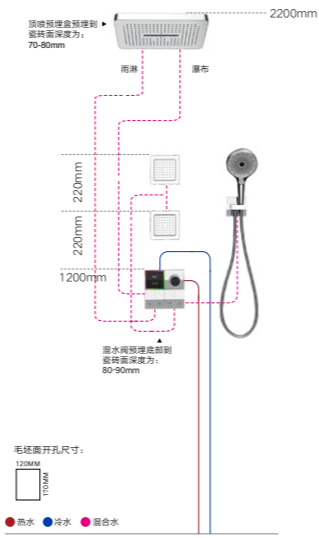

21040
三功能恒温暗装淋浴花洒
3F constant temperature concealed shower
主体材质: 铜 / Material: Brass

C B W Q LG M

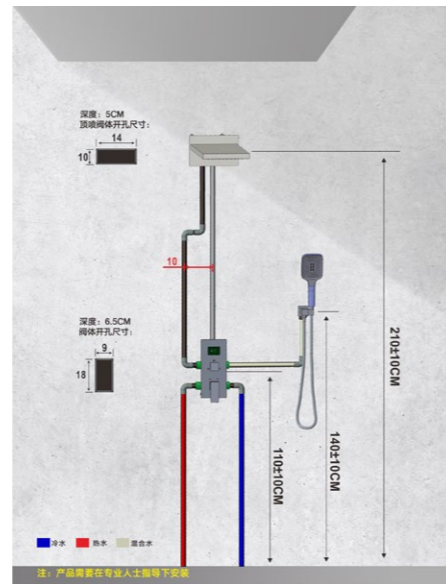

21041
三功能恒温暗装淋浴花洒
3F constant temperature concealed shower
主体材质: 铜 / Material: Brass

C B W Q LG M

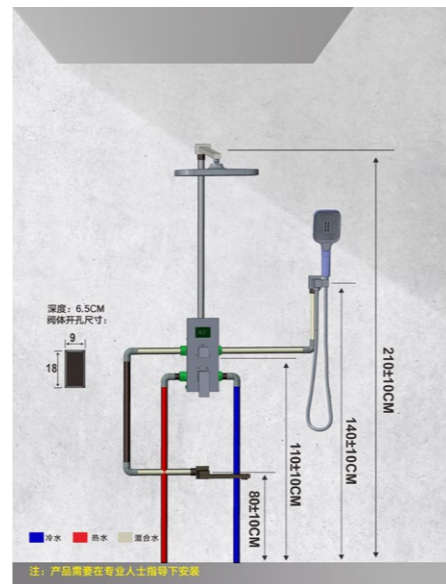

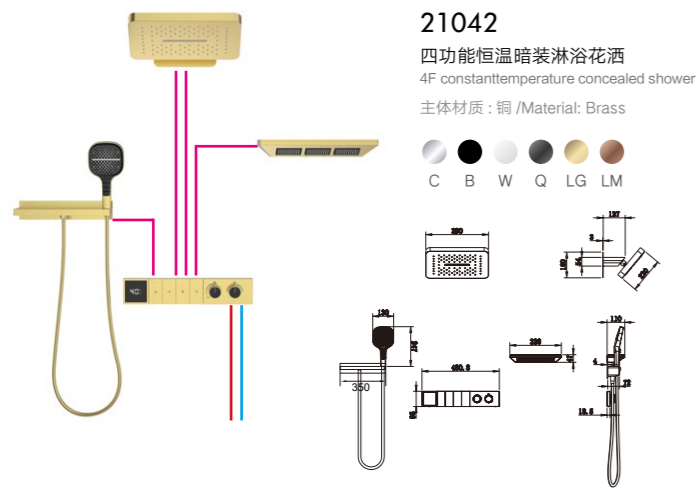

21042
四功能恒温暗装淋浴花洒
4F constant temperature concealed shower
主体材质: 铜 /Material: Brass

C B W Q LG LM

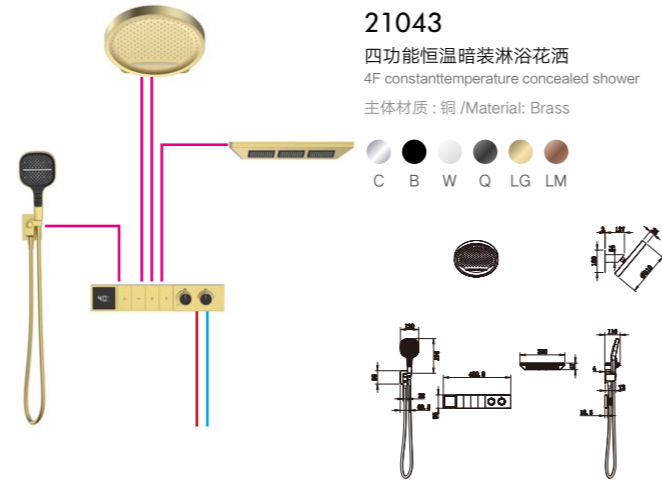

21043
四功能恒温暗装淋浴花洒
4F constant temperature concealed shower
主体材质: 铜 /Material: Brass

C B W Q LG LM



21048
二功能恒温暗装淋浴花洒
2F constant temperature concealed shower
主体材质: 铜 /Material: Brass

C B W Q LG LM



21049
二功能恒温暗装淋浴花洒
2F constant temperature concealed shower
主体材质: 铜 /Material: Brass

C B W Q LG LM

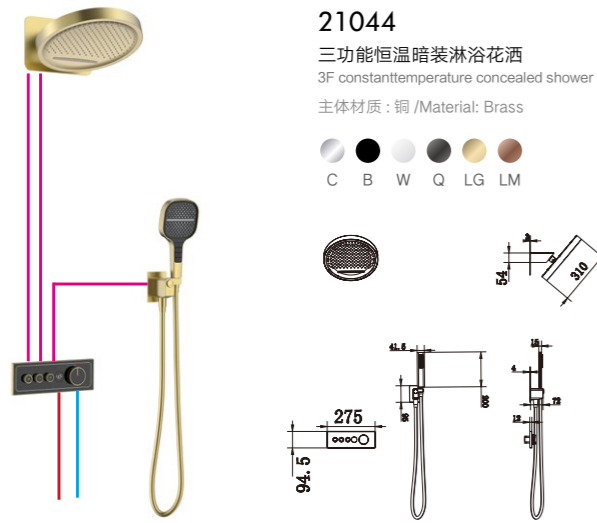

21044
三功能恒温暗装淋浴花洒
3F constant temperature concealed shower
主体材质: 铜 /Material: Brass

C B W Q LG LM



21045
三功能恒温暗装淋浴花洒
3F constant temperature concealed shower
主体材质: 铜 /Material: Brass

C B W Q LG LM



21050
二功能暗装淋浴花洒
2F concealed shower set
主体材质: 铜 /Material: Brass

C B W Q LG LM



21051
二功能暗装淋浴花洒
2F concealed shower set
主体材质: 铜 /Material: Brass

C B W Q LG LM



21046
二功能恒温暗装淋浴花洒
2F constant temperature concealed shower
主体材质: 铜 /Material: Brass

C B W Q LG LM



21047
三功能恒温暗装淋浴花洒
3F constant temperature concealed shower
主体材质: 铜 /Material: Brass

C B W Q LG LM



21052
二功能暗装淋浴花洒
2F concealed shower
主体材质: 铜 /Material: Brass

C B W Q LG LM



21053
二功能暗装淋浴花洒
2F concealed shower
主体材质: 铜 /Material: Brass

C B W Q LG LM



21054
二功能暗装淋浴花洒
2F concealed shower
主体材质：铜 /Material: Brass
C B Q LG LM



21055
三功能暗装淋浴花洒
3F concealed shower
主体材质：铜 /Material: Brass
C B Q LG LM



21056
三功能暗装淋浴花洒
3F concealed shower
主体材质：铜 /Material: Brass
C B



21057
三功能暗装淋浴花洒
3F concealed shower
主体材质：铜 /Material: Brass
C



21058
三功能暗装淋浴花洒
3F concealed shower
主体材质：铜 /Material: Brass
C



21059
二功能暗装淋浴花洒
2F concealed shower
主体材质：铜 /Material: Brass
C

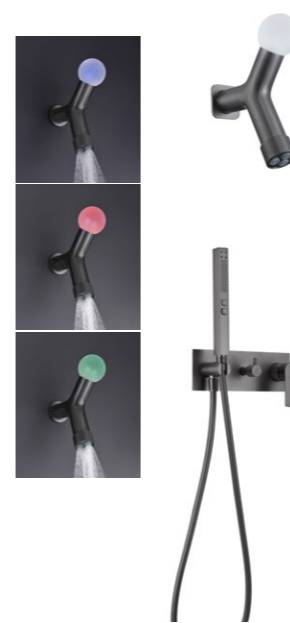

21060
二功能暗装淋浴花洒
2F concealed shower
主体材质：铜 /Material: Brass
C B W Q LG



21061
二功能暗装淋浴花洒
2F concealed shower
主体材质：铜 /Material: Brass
C B W Q LG



21062
三功能暗装淋浴花洒
3F concealed shower
主体材质：铜 /Material: Brass
C B W Q LG M



21063
三功能暗装淋浴花洒
3F concealed shower
主体材质：铜 /Material: Brass
C B W Q LG



21064
三功能暗装淋浴花洒
3F concealed shower
主体材质：铜 /Material: Brass
C B W Q LG



21065
三功能暗装淋浴花洒
3F concealed shower
主体材质：铜 /Material: Brass
C B W Q LG



21069
三功能暗装淋浴花洒
3F concealed shower
主体材质：铜 /Material: Brass
C B Q



21070
二功能暗装淋浴花洒
2F concealed shower
主体材质：铜 /Material: Brass
C B Q



21071
二功能暗装淋浴花洒
2F concealed shower
主体材质：铜 /Material: Brass
C B Q



21066
三功能暗装淋浴花洒
3F concealed shower
主体材质：铜 /Material: Brass
C B W Q LG M



21067
二功能暗装淋浴花洒
2F concealed shower
主体材质：铜 /Material: Brass
C B W Q LG



21068
三功能暗装淋浴花洒
3F concealed shower
主体材质：铜 /Material: Brass
C B Q



21072
二功能暗装淋浴花洒
2F concealed shower
主体材质：铜 /Material: Brass
C B W Q LG



21073
三功能暗装淋浴花洒
3F concealed shower
主体材质：铜 /Material: Brass
C B W Q LG



21074
三功能暗装淋浴花洒
3F concealed shower
主体材质：铜 /Material: Brass
C B Q

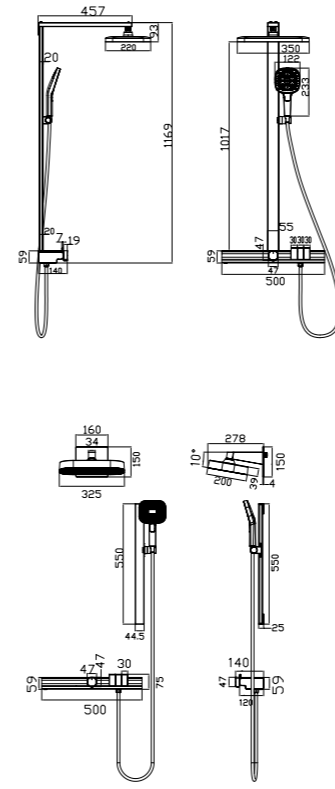

22001
三功能恒温明装花洒
3-Function Shower set
主体材质: 铜 /Material: Brass
● ●
N Q



22002
三功能恒温暗装花洒
3-Function In-wall Shower set
主体材质: 铜 /Material: Brass
● ●
N Q



22003
二功能恒温简易花洒
2-Function Simple Shower
主体材质: 铜 /Material: Brass
● ●
N Q



22004 恒温 / 冷热
四功能明装花洒
4-Function Shower set
主体材质: PPA /Material: PPA
● ●
W Q



22005 恒温 / 冷热
四功能明装花洒
4-Function Shower set
主体材质: PPA /Material: PPA
● ●
W Q

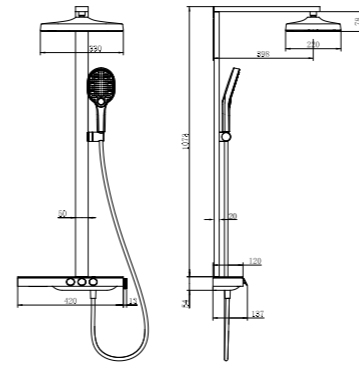

22006
二功能恒温简易花洒
2-Function Simple Shower
主体材质: 铜 /Material: Brass
● ●
W Q



22007
三功能恒温明装花洒
3-Function Shower set
主体材质: 铜 /Material: Brass
● ●
W Q



22008
四功能恒温明装花洒
4-Function Shower set
主体材质: 铜 /Material: Brass
● ●
W Q

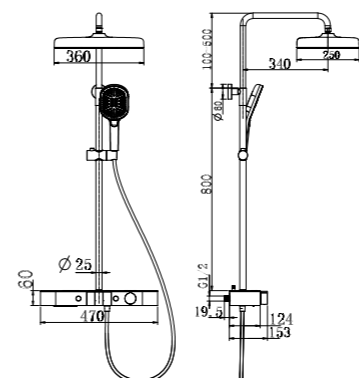

22009
二功能恒温简易花洒
2-Function Simple Shower
主体材质: 铜 /Material: Brass
● ● ●
C W Q



22010
三功能恒温暗装淋浴花洒
3F concealed shower
主体材质: 铜 /Material: Brass
● ● ●
C W Q



22011
三功能恒温明装花洒
3-Function Shower set
主体材质: 铜 /Material: Brass
● ● ●
C W Q

Without doubt, art and beauty are what we are all along pursuing, but to us the most important thing is that we must think about human-oriented thought

ARTISTIC AND AESTHETIC



22012

二功能简易花洒
2-Function Simple Shower
主体材质: 铜 /Material: Brass



22013

三功能明装花洒
3-Function Shower set
主体材质: 铜 /Material: Brass



22014

四功能明装花洒
4-Function Shower set
主体材质: 铜 /Material: Brass



22015

三功能暗装淋浴花洒
3F concealed shower
主体材质: 铜 /Material: Brass

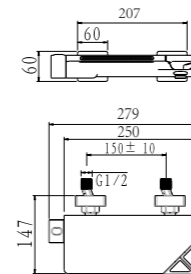

22016

单功能浴缸龙头
1-Function Bathtub Faucet
主体材质: 铜 /Material: Brass

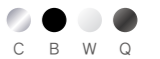

22017

二功能简易花洒
2-Function Simple Shower
主体材质: 铜 /Material: Brass





22018

三功能明装花洒
3-Function Shower set

主体材质: 铜 /Material: Brass

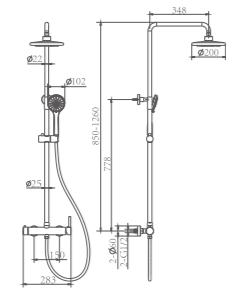

22019

三功能明装花洒
3-Function Shower set

主体材质: 铜 /Material: Brass

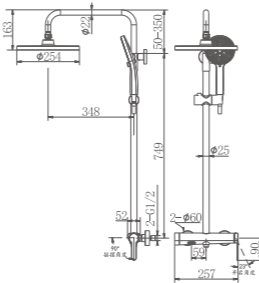

22024

三功能明装花洒
3-Function Shower set

主体材质: 铜 /Material: Brass

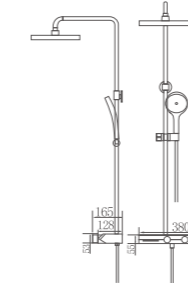

22025

三功能明装花洒
3-Function Shower set

主体材质: 铜 /Material: Brass

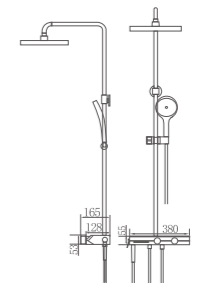

22020

三功能明装花洒
3-Function Shower set

主体材质: 铜 /Material: Brass

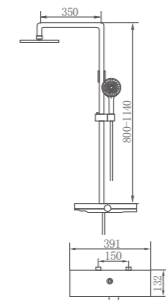

22021

二功能简易花洒
2-Function Simple Shower

主体材质: 铜 /Material: Brass

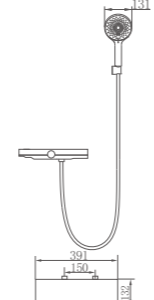

22026

三功能明装花洒
3-Function Shower set

主体材质: 铜 /Material: Brass

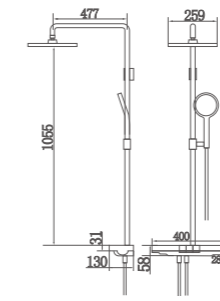

22027

三功能明装花洒
3-Function Shower set

主体材质: 铜 /Material: Brass

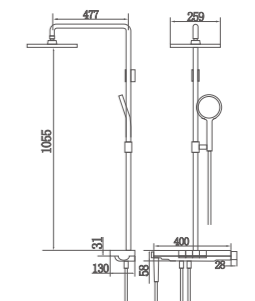

22022

三功能明装花洒
3-Function Shower set

主体材质: 铜 /Material: Brass

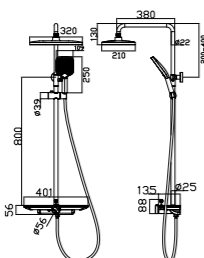

22023

二功能简易花洒
2-Function Simple Shower

主体材质: 铜 /Material: Brass

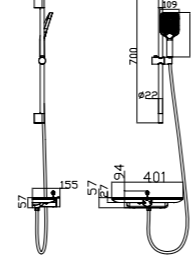

22028

二功能简易花洒
2-Function Simple Shower

主体材质: 铜 /Material: Brass

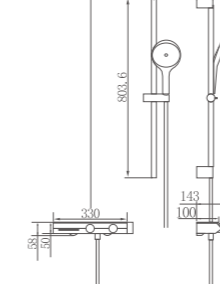

22029

二功能简易花洒
2-Function Simple Shower

主体材质: 铜 /Material: Brass

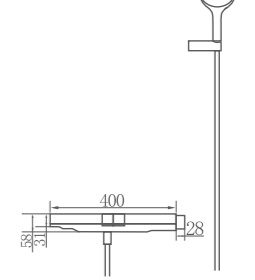



22033
三功能明装花洒
3-Function Shower set
主体材质：铜 /Material: Brass



22034
四功能明装花洒
4-Function Shower set
主体材质：铜 /Material: Brass



22030 (恒温 / 冷热)
三功能明装花洒
3-Function Shower set
主体材质：铜 /Material: Brass



22031 (恒温 / 冷热)
三功能简易花洒
3-Function Simple Shower
主体材质：铜 /Material: Brass



22032 (恒温 / 冷热)
两功能浴缸龙头
2-Function Bathtub Faucet
主体材质：铜 /Material: Brass



22035
三功能简易花洒
3-Function Simple Shower
主体材质：铜 /Material: Brass



22036
三功能明装花洒
3-Function Shower set
主体材质：铜 /Material: Brass



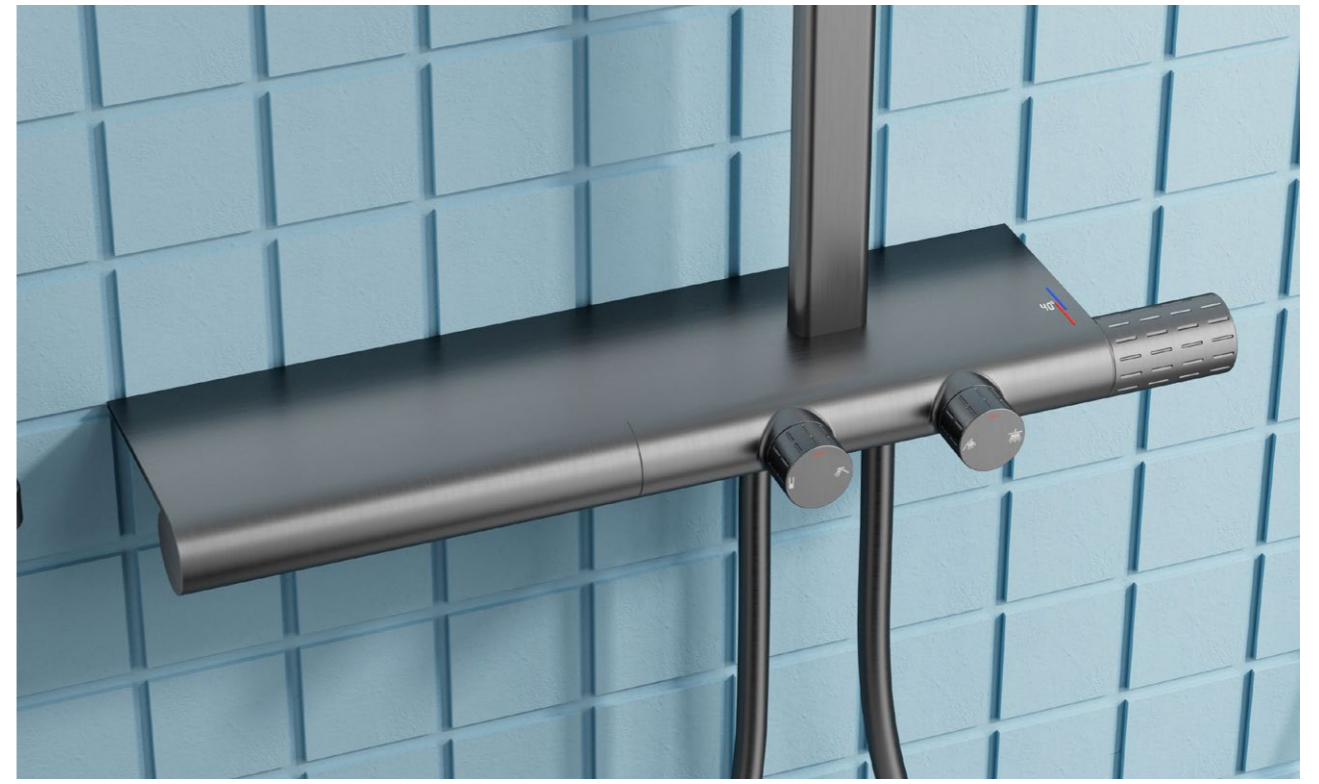

22037
四功能暗装花洒
4-Function In-wall Shower set
主体材质：铜 /Material: Brass

● C ● B ● W ● Q ● LG



22038
四功能暗装花洒
4-Function In-wall Shower set
主体材质：铜 /Material: Brass

● C ● B ● W ● Q ● LG



22039
四功能暗装花洒
4-Function In-wall Shower set
主体材质：铜 /Material: Brass

● C ● B ● W ● Q ● LG



22040
三功能明装花洒
3-Function Shower set
主体材质：铜 /Material: Brass

● C ● B ● W ● Q ● LG



22041
二功能恒温简易花洒
2-Function Simple Shower
主体材质：铜 /Material: Brass



22042
三功能恒温明装花洒
3-Function Shower set
主体材质：铜 /Material: Brass



22043
四功能明装花洒
4-Function Shower set
主体材质：铜 /Material: Brass



22044 (恒温/冷热)

四功能明装花洒
4-Function Shower set

主体材质: 铜 /Material: Brass



22045

四功能明装花洒
4-Function Shower set

主体材质: 铜 /Material: Brass

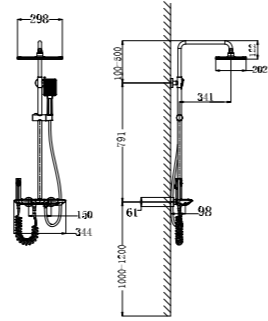
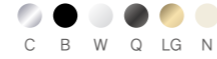

22050

四功能明装花洒
4-Function Shower set

主体材质: 铜 /Material: Brass



22051

三功能简易花洒
3-Function Simple Shower

主体材质: 铜 /Material: Brass



22046

四功能明装花洒
4-Function Shower set

主体材质: 铜 /Material: Brass



22047

四功能明装花洒
4-Function Shower set

主体材质: 铜 /Material: Brass



22052

三功能明装花洒
3-Function Shower set

主体材质: 铜 /Material: Brass



22053

三功能简易花洒
3-Function Simple Shower

主体材质: 铜 /Material: Brass

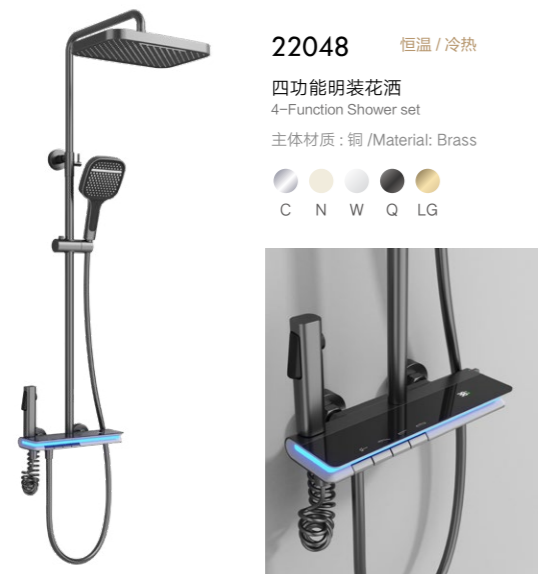

22048 (恒温/冷热)

四功能明装花洒
4-Function Shower set

主体材质: 铜 /Material: Brass



22049 (恒温/冷热)

四功能明装花洒
4-Function Shower set

主体材质: 铜 /Material: Brass



22054

三功能明装花洒
3-Function Shower set

主体材质: PPA/铜 /Material: PPA/Brass

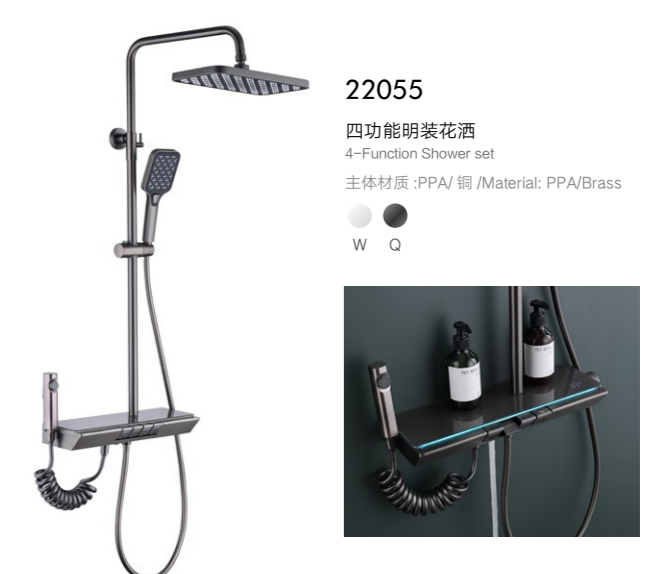

22055

四功能明装花洒
4-Function Shower set

主体材质: PPA/铜 /Material: PPA/Brass

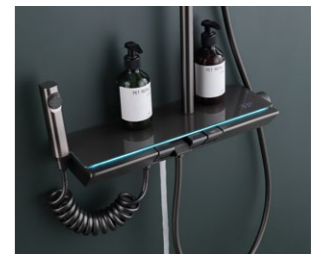



22056

三功能明装花洒
3-Function Shower set

主体材质: 铜 /Material: Brass



C W Q



22057

四功能明装花洒
4-Function Shower set

主体材质: 铜 /Material: Brass



C W Q



22062

三功能恒温暗装花洒
3-Function In-wall Shower set

主体材质: 铜 /Material: Brass



C B Q LG

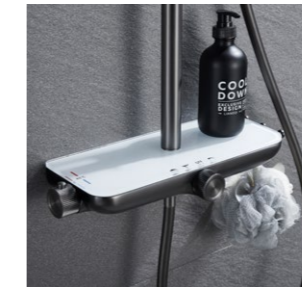

22063

三功能恒温暗装花洒
3-Function In-wall Shower set

主体材质: 铜 /Material: Brass



C B Q LG



22058

三功能明装花洒
3-Function Shower set

主体材质: 铜 /Material: Brass



C B W Q



22059

四功能明装花洒
4-Function Shower set

主体材质: 铜 /Material: Brass



W Q



22064

三功能明装花洒
3-Function Shower set

主体材质: 铜 /Material: Brass



C B Q



22065

四功能明装花洒
4-Function Shower set

主体材质: 铜 /Material: Brass



C W Q

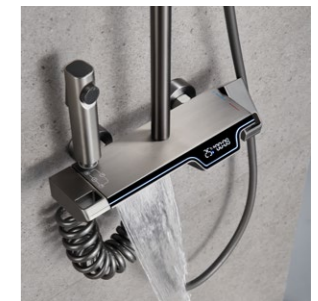

22060

三功能恒温明装花洒
3-Function Shower set

主体材质: 铜 /Material: Brass



C B W Q LG

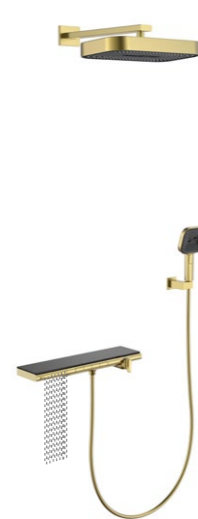
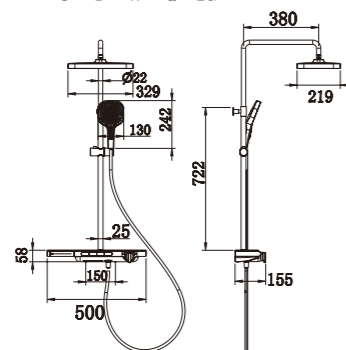

22061

三功能恒温暗装花洒
3-Function In-wall Shower set

主体材质: 铜 /Material: Brass



C B W Q LG



22066

三功能明装花洒
3-Function Shower set

主体材质: 铜 /Material: Brass



C N W Q LG



22067

二功能简易花洒
2-Function Simple Shower

主体材质: 铜 /Material: Brass



C N W Q LG

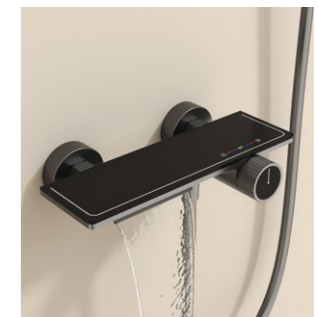



22068

三功能明装花洒
3-Function Shower set

主体材质: 铜 /Material: Brass



22069

四功能明装花洒
4-Function Shower set

主体材质: 铜 /Material: Brass



22070

四功能明装花洒
4-Function Shower set

主体材质: 铜 /Material: Brass



22071

三功能明装花洒
3-Function Shower set

主体材质: 铜 /Material: Brass



22072

二功能简易花洒
2-Function Simple Shower

主体材质: 铜 /Material: Brass



22073

二功能简易花洒
2-Function Simple Shower

主体材质: 铜 /Material: Brass



22074

四功能明装花洒
4-Function Shower set

主体材质: 铜 /Material: Brass



22075

四功能明装花洒
4-Function Shower set

主体材质: 铜 /Material: Brass



22076

三功能明装花洒
3-Function Shower set

主体材质: 铜 /Material: Brass



22077 有三功能款

四功能明装花洒
4-Function Shower set

主体材质: 铜 /Material: Brass



22078

三功能简易花洒
3-Function Simple Shower

主体材质: 铜 /Material: Brass





22079

二功能简易花洒
2-Function Simple Shower
主体材质：铜 /Material: Brass



22080

二功能明装花洒
2-Function Shower set
主体材质：铜 /Material: Brass



22081

三功能明装花洒
3-Function Shower set
主体材质：铜 /Material: Brass



22082

四功能明装花洒
4-Function Shower set
主体材质：铜 /Material: Brass

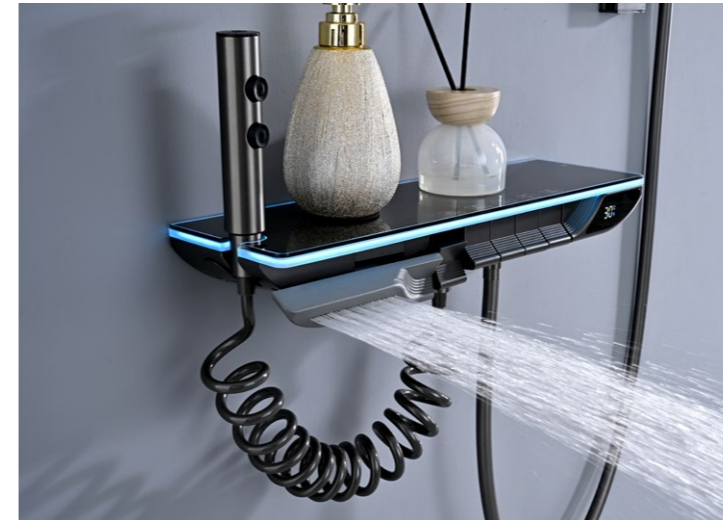

22083

五功能恒温明装花洒
4-Function Shower set
主体材质：内芯 PPA+ 外壳 ABS
/Material: PPA+ABS



22084

五功能恒温暗装花洒
5-Function In-wall Shower set
主体材质：内芯 PPA+ 外壳 ABS
/Material: PPA+ABS



22085

三功能明装花洒
3-Function Shower set
主体材质：铜 /Material: Brass



22086

二功能简易花洒
2-Function Simple Shower
主体材质：铜 /Material: Brass





22087
四功能明装花洒
4-Function Shower set
主体材质: 铜 /Material: Brass
C W Q



22088
四功能明装花洒
4-Function Shower set
主体材质: 铜 /Material: Brass
C W Q



22089
三功能明装花洒
3-Function Shower set
主体材质: 铜 /Material: Brass
C W Q



22090
二功能简易花洒
2-Function Simple Shower
主体材质: 铜 /Material: Brass
C W Q



22095
三功能明装花洒
3-Function Shower set
主体材质: 铜 /Material: Brass
C B W Q



22096
四功能明装花洒
4-Function Shower set
主体材质: 铜 /Material: Brass
C B W Q



22097
二功能简易花洒
2-Function Simple Shower
主体材质: 铜 /Material: Brass
C B W Q



22098
三功能简易花洒
3-Function Simple Shower
主体材质: 铜 /Material: Brass
C B W Q



22091
三功能明装花洒
3-Function Shower set
主体材质: 铜 /Material: Brass
C B Q LG



22092
三功能恒温明装花洒
3-Function Shower set
主体材质: 铜 /Material: Brass
C Q



22093
四功能明装花洒
4-Function Shower set
主体材质: 铜 /Material: Brass
C Q



22094
单功能简易花洒
1-Function Simple Shower
主体材质: 铜 /Material: Brass
C B Q LG



22099
三功能明装花洒
3-Function Shower set
主体材质: 铜 /Material: Brass
C W Q



22100
四功能明装花洒
4-Function Shower set
主体材质: 铜 /Material: Brass
C W Q



22101 冷热 / 恒温
三功能恒温明装花洒
3-Function Shower set
主体材质: 铜 /Material: Brass
B W Q



22102 冷热 / 恒温
四功能恒温明装花洒
4-Function Shower set
主体材质: 铜 /Material: Brass
Q



22103

四功能明装花洒
4-Function Shower set

主体材质: 铜 / Material: Brass



22104

四功能明装花洒
4-Function Shower set

主体材质: 铜 / Material: Brass

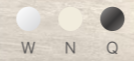

22105

四功能明装花洒
4-Function Shower set

主体材质: 铜 / Material: Brass



22106

四功能明装花洒
4-Function Shower set

主体材质: 铜 / Material: Brass



22107

四功能明装花洒
4-Function Shower set

主体材质: 铜 / Material: Brass



22108

四功能明装花洒
4-Function Shower set

主体材质: 铜 / Material: Brass



22109

四功能明装花洒
4-Function Shower set

主体材质: 铜 / Material: Brass



22110

四功能明装花洒
4-Function Shower set

主体材质: 铜 / Material: Brass



22111

四功能明装花洒
4-Function Shower set

主体材质: 铜 / Material: Brass



22112

四功能明装花洒
4-Function Shower set

主体材质: 铜 / Material: Brass





23001

落地浴缸龙头
Free Standing Bathtub Faucet
主体材质: 铜 /Material: Brass

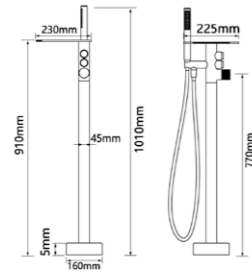

23002

落地浴缸龙头
Free Standing Bathtub Faucet
主体材质: 铜 /Material: Brass

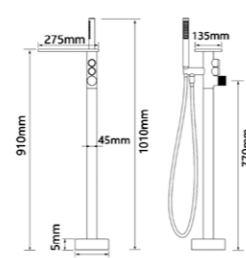

23007

落地浴缸龙头
Free Standing Bathtub Faucet
主体材质: 铜 /Material: Brass

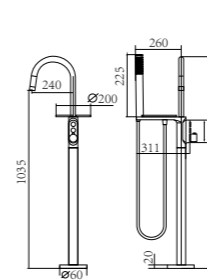

23008

落地浴缸龙头
Free Standing Bathtub Faucet
主体材质: 铜 /Material: Brass

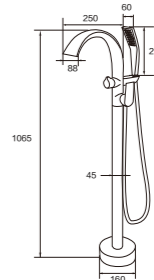

23003

落地浴缸龙头
Free Standing Bathtub Faucet
主体材质: 铜 /Material: Brass

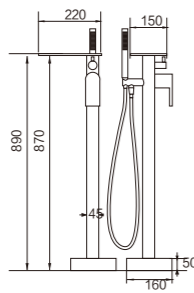

23004

落地浴缸龙头
Free Standing Bathtub Faucet
主体材质: 铜 /Material: Brass

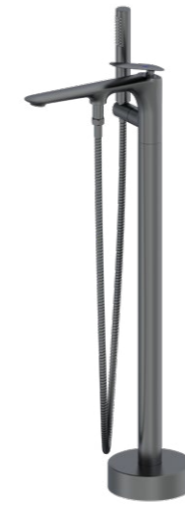

23009

落地浴缸龙头
Free Standing Bathtub Faucet
主体材质: 铜 /Material: Brass

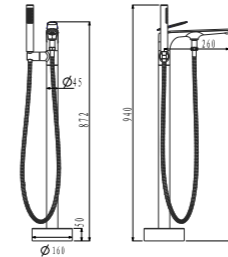

23010

落地浴缸龙头
Free Standing Bathtub Faucet
主体材质: 铜 /Material: Brass

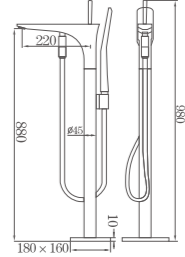

23005

落地浴缸龙头
Free Standing Bathtub Faucet
主体材质: 铜 /Material: Brass

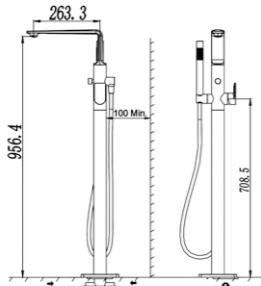

23006

落地浴缸龙头
Free Standing Bathtub Faucet
主体材质: 铜 /Material: Brass

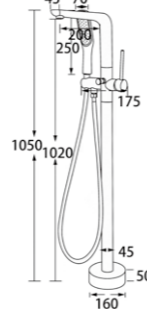

23011

落地浴缸龙头
Free Standing Bathtub Faucet
主体材质: 铜 /Material: Brass

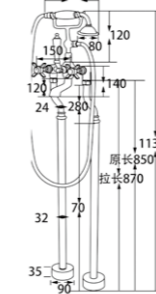

23012

落地浴缸龙头
Free Standing Bathtub Faucet
主体材质: 铜 /Material: Brass

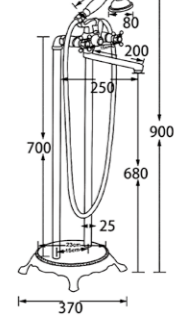



23013
落地浴缸龙头
Free Standing Bathtub Faucet
主体材质：铜 /Material: Brass
C G



23014
落地浴缸龙头
Free Standing Bathtub Faucet
主体材质：铜 /Material: Brass
C B



23015
落地浴缸龙头
Free Standing Bathtub Faucet
主体材质：铜 /Material: Brass
C B



23016
落地浴缸龙头
Free Standing Bathtub Faucet
主体材质：铜 /Material: Brass
C Q LG



23017
落地浴缸龙头
Free Standing Bathtub Faucet
主体材质：铜 /Material: Brass
C G



23018
落地浴缸龙头
Free Standing Bathtub Faucet
主体材质：铜 /Material: Brass
C G



23019
落地浴缸龙头
Free Standing Bathtub Faucet
主体材质：铜 /Material: Brass
C G



23020
落地浴缸龙头
Free Standing Bathtub Faucet
主体材质：铜 /Material: Brass
C G



25001
双把分体面盆龙头
Single handle basin faucet
主体材质：铜 /Material: Brass

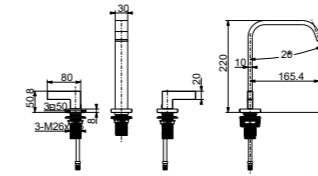

25002
双把分体面盆龙头
Single handle basin faucet
主体材质：铜 /Material: Brass

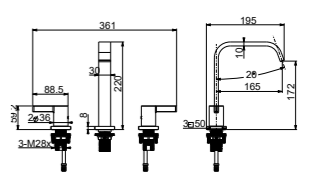

25003
双把分体面盆龙头
Single handle basin faucet
主体材质：铜 /Material: Brass

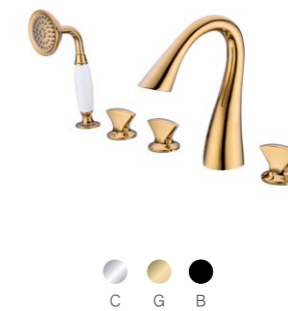
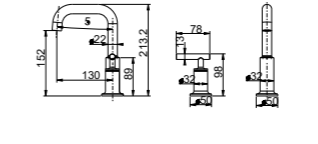

25004
分体浴缸龙头
Single handle Bathtub Faucet
主体材质：铜 /Material: Brass

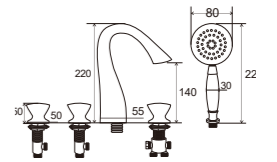

25005
双把分体面盆龙头
Single handle basin faucet
主体材质：铜 /Material: Brass

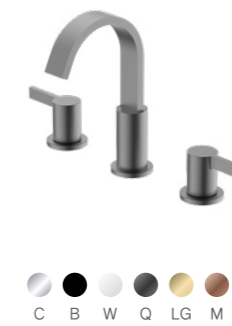
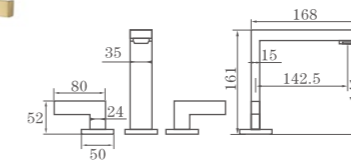

25006
双把分体面盆龙头
Single handle basin faucet
主体材质：铜 /Material: Brass

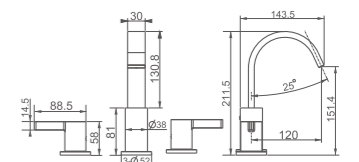

25007
双把分体面盆龙头
Single handle basin faucet
主体材质：铜 /Material: Brass

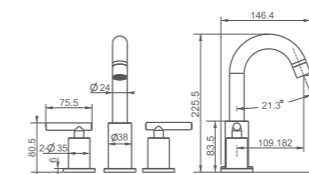

25008
双把分体面盆龙头
Single handle basin faucet
主体材质：铜 /Material: Brass

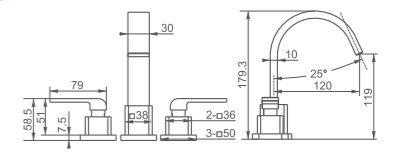



25009
双把分体面盆龙头
Single handle basin faucet
主体材质: 铜 /Material: Brass



25010
分体浴缸龙头
Single handle Bathtub Faucet
主体材质: 铜 /Material: Brass



25011
分体浴缸龙头
Single handle Bathtub Faucet
主体材质: 铜 /Material: Brass



25012
分体浴缸龙头
Single handle Bathtub Faucet
主体材质: 铜 /Material: Brass



25101
单把入墙面盆龙头
Single handle basin faucet
主体材质: 铜 /Material: Brass

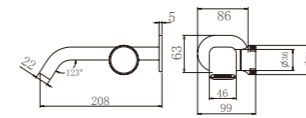

25013
双把分体面盆龙头
Single handle basin faucet
主体材质: 铜 /Material: Brass



25014
分体浴缸龙头
Single handle Bathtub Faucet
主体材质: 铜 /Material: Brass

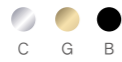

25015
分体浴缸龙头
Single handle Bathtub Faucet
主体材质: 铜 /Material: Brass

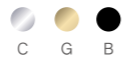

25016
分体浴缸龙头
Single handle Bathtub Faucet
主体材质: 铜 /Material: Brass

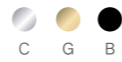

25017
双把分体面盆龙头
Single handle basin faucet
主体材质: 铜 /Material: Brass



25018
分体浴缸龙头
Single handle Bathtub Faucet
主体材质: 铜 /Material: Brass



25019
浴缸龙头
Bathtub Faucet
主体材质: 铜 /Material: Brass

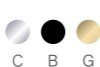

25020
双把分体面盆龙头
Single handle basin faucet
主体材质: 铜 /Material: Brass



25103
单把入墙面盆龙头
Single handle basin faucet
主体材质: 铜 /Material: Brass

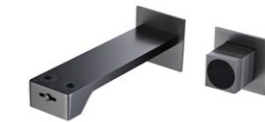
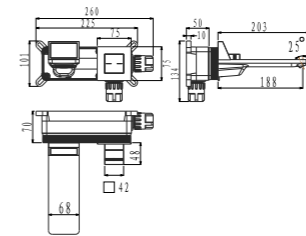

25104
单把入墙面盆龙头
Single handle basin faucet
主体材质: 铜 /Material: Brass

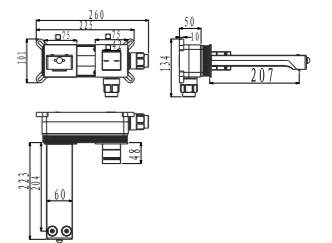

25105
单把入墙面盆龙头
Single handle basin faucet
主体材质: 铜 /Material: Brass

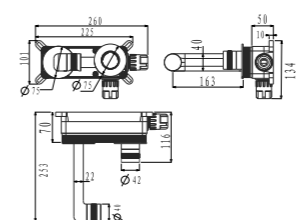

25106
单把入墙面盆龙头
Single handle basin faucet
主体材质: 铜 /Material: Brass

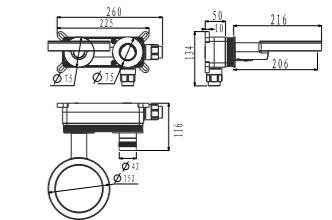

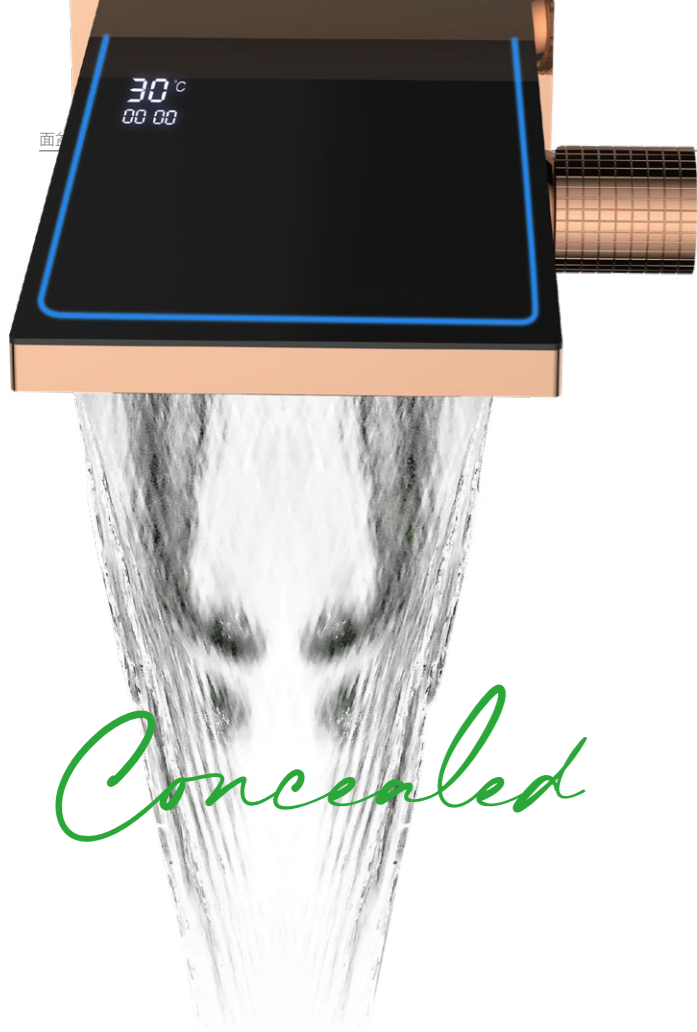

Such as light, wanton dance, take care to empty, instantly close your eyes to listen, quietly whisper, elegant calm, through the light, publicity and profound, quiet and dynamic, highlighting the ultimate classic charm

如光，肆意舞动，当心放空，顷刻闭眼倾听，轻声细语，优雅从容透过光芒，张扬又深邃，沉静又动感，彰显极致经典魅力

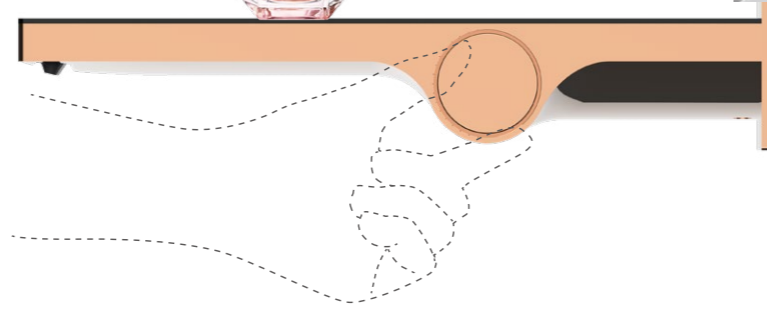

25107

单把入墙面盆龙头
Single handle basin faucet

主体材质：铜 / Material: Brass

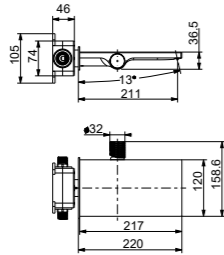

25108

单把面盆龙头
Single handle basin faucet

主体材质：铜 / Material: Brass

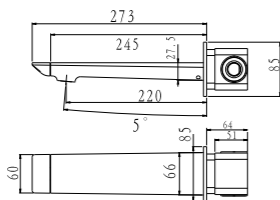

25109

单把入墙面盆龙头
Single handle basin faucet

主体材质：铜 / Material: Brass



25110

单把入墙面盆龙头
Single handle basin faucet

主体材质：铜 / Material: Brass



25111

单把入墙面盆龙头
Single handle basin faucet

主体材质：铜 / Material: Brass



25112

单把入墙面盆龙头
Single handle basin faucet

主体材质：铜 / Material: Brass



25113

单把入墙面盆龙头
Single handle basin faucet

主体材质：铜 / Material: Brass



25114

单把入墙面盆龙头
Single handle basin faucet

主体材质：铜 / Material: Brass



25115

单把入墙面盆龙头
Single handle basin faucet

主体材质：铜 / Material: Brass



25116

单把入墙面盆龙头
Single handle basin faucet

主体材质：铜 / Material: Brass





25117

单把入墙面盆龙头
Single handle basin faucet
主体材质: 铜 /Material: Brass



25126

单把入墙面盆龙头
Single handle basin faucet
主体材质: 铜 /Material: Brass



25127

单把入墙面盆龙头
Single handle basin faucet
主体材质: 铜 /Material: Brass



25128

单把入墙面盆龙头
Single handle basin faucet
主体材质: 铜 /Material: Brass



25129

单把入墙面盆龙头
Single handle basin faucet
主体材质: 铜 /Material: Brass



25118

单把入墙面盆龙头
Single handle basin faucet
主体材质: 铜 /Material: Brass



25119

单把入墙面盆龙头
Single handle basin faucet
主体材质: 铜 /Material: Brass

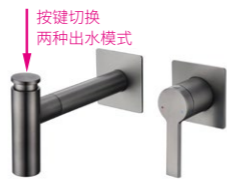
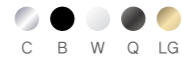

25120

单把入墙面盆龙头
Single handle basin faucet
主体材质: 铜 /Material: Brass

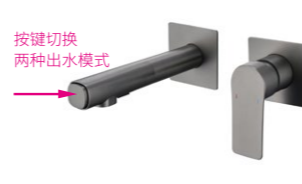

25121

单把入墙面盆龙头
Single handle basin faucet
主体材质: 铜 /Material: Brass



25130

单把入墙面盆龙头
Single handle basin faucet
主体材质: 铜 /Material: Brass



25131

单把入墙面盆龙头
Single handle basin faucet
主体材质: 铜 /Material: Brass



25132

单把入墙面盆龙头
Single handle basin faucet
主体材质: 铜 /Material: Brass



25133

单把入墙面盆龙头
Single handle basin faucet
主体材质: 铜 /Material: Brass



25122

单把入墙面盆龙头
Single handle basin faucet
主体材质: 铜 /Material: Brass



25123

双把入墙面盆龙头
Double handle basin faucet
主体材质: 铜 /Material: Brass

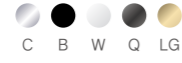

25124

双把入墙面盆龙头
Double handle basin faucet
主体材质: 铜 /Material: Brass

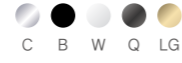

25125

双把入墙面盆龙头
Double handle basin faucet
主体材质: 铜 /Material: Brass



25134

抽拉入墙面盆龙头
Single handle basin faucet
主体材质: 铜 /Material: Brass



25135

抽拉入墙面盆龙头
Single handle basin faucet
主体材质: 铜 /Material: Brass



25136

抽拉入墙面盆龙头
Single handle basin faucet
主体材质: 铜 /Material: Brass



25137

抽拉入墙面盆龙头
Single handle basin faucet
主体材质: 铜 /Material: Brass





25205

单把面盆龙头
Single handle basin faucet
主体材质: 铜 /Material: Brass

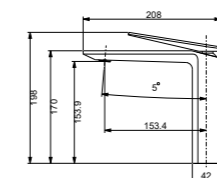
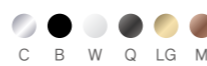

25206

单把面盆龙头
Single handle basin faucet
主体材质: 铜 /Material: Brass

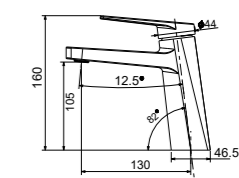

25207

单把面盆龙头
Single handle basin faucet
主体材质: 铜 /Material: Brass

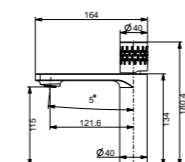

25208

单把面盆龙头
Single handle basin faucet
主体材质: 铜 /Material: Brass

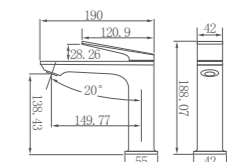

25201

单把面盆龙头
Single handle basin faucet
主体材质: 铜 /Material: Brass

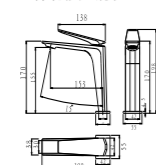

25202

单把面盆龙头
Single handle basin faucet
主体材质: 铜 /Material: Brass

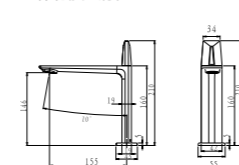

25209

单把面盆龙头
Single handle basin faucet
主体材质: 铜 /Material: Brass

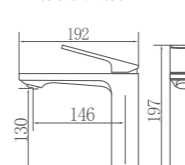

25210

单把面盆龙头
Single handle basin faucet
主体材质: 铜 /Material: Brass

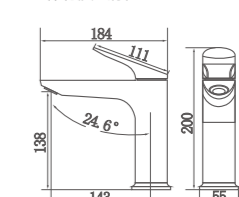

25203

单把面盆龙头
Single handle basin faucet
主体材质: 铜 /Material: Brass

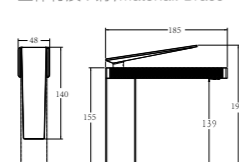

25204

单把面盆龙头
Single handle basin faucet
主体材质: 铜 /Material: Brass

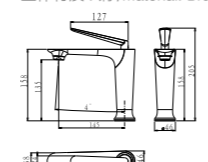

25211

单把面盆龙头
Single handle basin faucet
主体材质: 铜 /Material: Brass

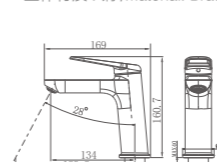

25212

单把面盆龙头
Single handle basin faucet
主体材质: 铜 /Material: Brass

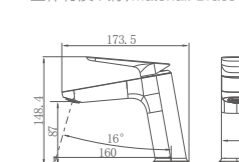



25229
单把手盆龙头
Single handle basin faucet
主体材质：铜 /Material: Brass

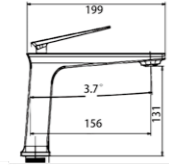

25230
单把手盆龙头
Single handle basin faucet
主体材质：铜 /Material: Brass

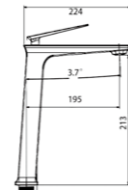

25237
单把手盆龙头
Single handle basin faucet
主体材质：铜 /Material: Brass

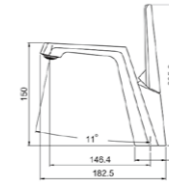

25238
单把手盆龙头
Single handle basin faucet
主体材质：铜 /Material: Brass

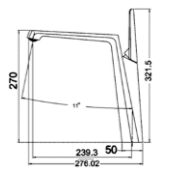

25231
单把手盆龙头
Single handle basin faucet
主体材质：铜 /Material: Brass

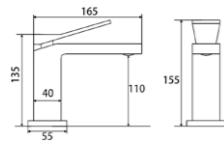

25232
单把手盆龙头
Single handle basin faucet
主体材质：铜 /Material: Brass

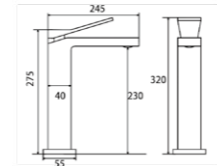

25239
单把手盆龙头
Single handle basin faucet
主体材质：铜 /Material: Brass

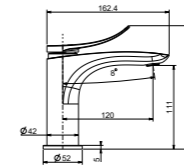

25240
单把手盆龙头
Single handle basin faucet
主体材质：铜 /Material: Brass

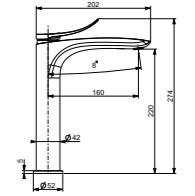

25233
单把手盆龙头
Single handle basin faucet
主体材质：铜 /Material: Brass

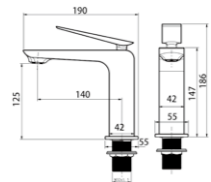

25234
单把手盆龙头
Single handle basin faucet
主体材质：铜 /Material: Brass

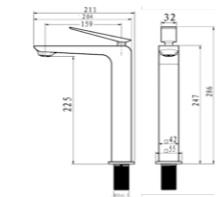

25241
单把手盆龙头
Single handle basin faucet
主体材质：铜 /Material: Brass

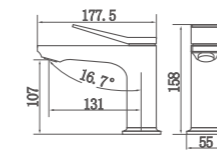

25242
单把手盆龙头
Single handle basin faucet
主体材质：铜 /Material: Brass

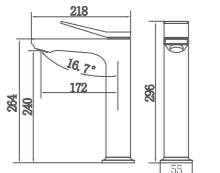

25235
单把手盆龙头
Single handle basin faucet
主体材质：铜 /Material: Brass

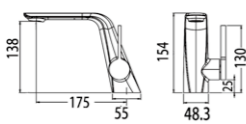

25236
单把手盆龙头
Single handle basin faucet
主体材质：铜 /Material: Brass

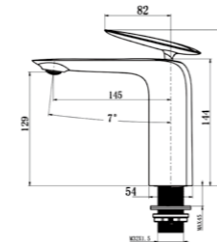

25243
单把手盆龙头
Single handle basin faucet
主体材质：铜 /Material: Brass

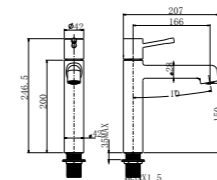

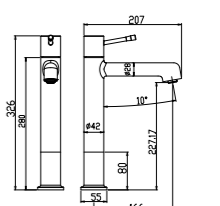

25244
单把手盆龙头
Single handle basin faucet
主体材质：铜 /Material: Brass





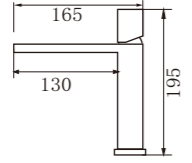

25245
单把手盆龙头
Single handle basin faucet
主体材质: 铜 /Material: Brass



25246
单把手盆龙头
Single handle basin faucet
主体材质: 铜 /Material: Brass

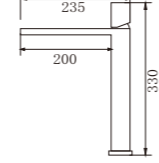

25247
单把手盆龙头
Single handle basin faucet
主体材质: 铜 /Material: Brass

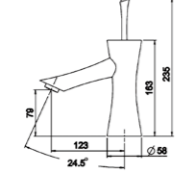

25248
单把手盆龙头
Single handle basin faucet
主体材质: 铜 /Material: Brass

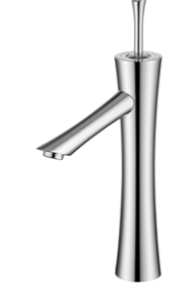



25249
单把手盆龙头
Single handle basin faucet
主体材质: 铜 /Material: Brass





25250
单把手盆龙头
Single handle basin faucet
主体材质: 铜 /Material: Brass





25251
单把手盆龙头
Single handle basin faucet
主体材质: 铜 /Material: Brass





25252
单把手盆龙头
Single handle basin faucet
主体材质: 铜 /Material: Brass





25253
单把手盆龙头
Single handle basin faucet
主体材质: 铜 /Material: Brass





25254
单把手盆龙头
Single handle basin faucet
主体材质: 铜 /Material: Brass





25255
单把手盆龙头
Single handle basin faucet
主体材质: 铜 /Material: Brass







25256
单把手盆龙头
Single handle basin faucet
主体材质: 铜 /Material: Brass





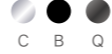

25257
单把手盆龙头
Single handle basin faucet
主体材质: 铜 /Material: Brass







25258
单把手盆龙头
Single handle basin faucet
主体材质: 铜 /Material: Brass







25259
单把手盆龙头
Single handle basin faucet
主体材质: 铜 /Material: Brass







25260
单把手盆龙头
Single handle basin faucet
主体材质: 铜 /Material: Brass







25261
单把手盆龙头
Single handle basin faucet
主体材质: 铜 /Material: Brass







25262
单把手盆龙头
Single handle basin faucet
主体材质: 铜 /Material: Brass





25263
单把手盆龙头
Single handle basin faucet
主体材质: 铜 /Material: Brass





25264
单把手盆龙头
Single handle basin faucet
主体材质: 铜 /Material: Brass





25273
单把手盆龙头
Single handle basin faucet
主体材质：铜 /Material: Brass



25274
单把手盆龙头
Single handle basin faucet
主体材质：铜 /Material: Brass



25275
单把手盆龙头
Single handle basin faucet
主体材质：铜 /Material: Brass



25276
单把手盆龙头
Single handle basin faucet
主体材质：铜 + 锌 /Material: Brass+Zinc



25265
单把手盆龙头
Single handle basin faucet
主体材质：铜 /Material: Brass



25266
单把手盆龙头
Single handle basin faucet
主体材质：铜 /Material: Brass



25267
单把手盆龙头
Single handle basin faucet
主体材质：铜 /Material: Brass



25268
单把手盆龙头
Single handle basin faucet
主体材质：铜 /Material: Brass



25277 恒温
单把手盆龙头
Single handle basin faucet
主体材质：铜 /Material: Brass

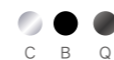

25278 恒温
单把手盆龙头
Single handle basin faucet
主体材质：铜 /Material: Brass

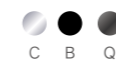

25279 恒温
单把手盆龙头
Single handle basin faucet
主体材质：铜 /Material: Brass



25280 恒温
单把手盆龙头
Single handle basin faucet
主体材质：铜 /Material: Brass



25269
单把手盆龙头
Single handle basin faucet
主体材质：铜 /Material: Brass



25270
单把手盆龙头
Single handle basin faucet
主体材质：铜 /Material: Brass



25271
单把手盆龙头
Single handle basin faucet
主体材质：铜 /Material: Brass



25272
单把手盆龙头
Single handle basin faucet
主体材质：铜 /Material: Brass

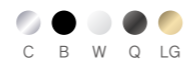

25281
单把手盆龙头
Single handle basin faucet
主体材质：铜 /Material: Brass

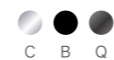

25282
单把抽拉厨房龙头
Pull-out kitchen mixer
主体材质：铜 /Material: Brass



25283 恒温
双把瀑布面盆龙头
Double handle Waterfall basin faucet
主体材质：铜 /Material: Brass



25284
单把手盆龙头
Single handle basin faucet
主体材质：铜 /Material: Brass





25285
单把面盆龙头
Single handle basin faucet
主体材质: 铜 + 锌 /Material: Brass+Zinc
C B Q W



25286
单把抽拉面盆龙头
Pull-out Basin Mixer
主体材质: 铜 + 锌 /Material: Brass+Zinc
C B Q



25287
单把抽拉面盆龙头
Pull-out Basin Mixer
主体材质: 铜 + 锌 /Material: Brass+Zinc
C W Q N



25288
单把抽拉面盆龙头
Pull-out Basin Mixer
主体材质: 铜 + 锌 /Material: Brass+Zinc
C W Q LG



25297
单把抽拉面盆龙头
Pull-out Basin Mixer
主体材质: 铜 /Material: Brass
C Q



25298
单把抽拉面盆龙头
Pull-out Basin Mixer
主体材质: 铜 /Material: Brass
C Q



25299 双水路净水
单把抽拉厨房龙头
Pull-out kitchen mixer
主体材质: 铜 /Material: Brass
C Q



25300
单把抽拉厨房龙头
Pull-out kitchen mixer
主体材质: 铜 /Material: Brass
C Q



25289
单把抽拉面盆龙头
Pull-out Basin Mixer
主体材质: 铜 + 锌 /Material: Brass+Zinc
C B Q W



25290
单把抽拉面盆龙头
Pull-out Basin Mixer
主体材质: 铜 + 锌 /Material: Brass+Zinc
C L B W Q



25291
单把抽拉面盆龙头
Pull-out Basin Mixer
主体材质: 铜 + 锌 /Material: Brass+Zinc
C W Q



25292
单把抽拉面盆龙头
Pull-out Basin Mixer
主体材质: 铜 + 锌 /Material: Brass+Zinc
C W Q



25301 数显 / 非数显
单把抽拉面盆龙头
Pull-out Basin Mixer
主体材质: 铜 /Material: Brass
C W Q



25302 数显 / 非数显
单把抽拉面盆龙头
Pull-out Basin Mixer
主体材质: 铜 /Material: Brass
C W Q



25303
单把抽拉面盆龙头
Pull-out Basin Mixer
主体材质: 铜 + 锌 /Material: Brass+Zinc
C B W Q LG



25304
单把抽拉面盆龙头
Pull-out Basin Mixer
主体材质: 铜 + 锌 /Material: Brass+Zinc
C W Q



25293
单把抽拉面盆龙头
Pull-out Basin Mixer
主体材质: 铜 /Material: Brass
C Q



25294
单把抽拉面盆龙头
Pull-out Basin Mixer
主体材质: 铜 /Material: Brass
C Q W



25295
单把抽拉面盆龙头
Pull-out Basin Mixer
主体材质: 铜 /Material: Brass
C Q W



25296
单把抽拉面盆龙头
Pull-out Basin Mixer
主体材质: 铜 /Material: Brass
C Q



25305
单把抽拉面盆龙头
Pull-out Basin Mixer
主体材质: 铜 + 锌 /Material: Brass+Zinc
C B W Q LG



25306
单把抽拉面盆龙头
Pull-out Basin Mixer
主体材质: 铜 + 锌 /Material: Brass+Zinc
C B W Q LG



25307
单把抽拉面盆龙头
Pull-out Basin Mixer
主体材质: 铜 + 锌 /Material: Brass+Zinc
C B W Q LG



25308
单把抽拉面盆龙头
Pull-out Basin Mixer
主体材质: 铜 + 锌 /Material: Brass+Zinc
C B W Q LG



25507
单把抽拉厨房龙头
Pull-out kitchen mixer
主体材质: 铜 / Material: Brass

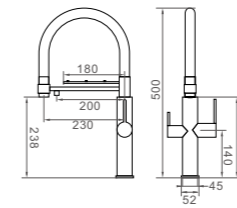

C B Q LG



25508
单把抽拉厨房龙头
Pull-out kitchen mixer
主体材质: 铜 / Material: Brass

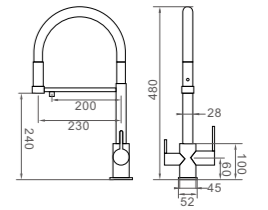

C B Q LG



25501 双水路净水 (带净水器)
抽拉厨房龙头
Pull-out kitchen mixer
主体材质: 铜 / Material: Brass

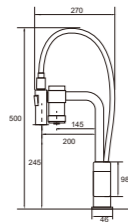

C B W Q LG



25502
单把抽拉厨房龙头
Pull-out kitchen mixer
主体材质: 铜 / Material: Brass

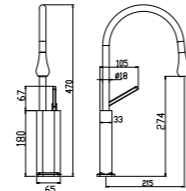

C B W Q LG M



25509
单把抽拉厨房龙头
Pull-out kitchen mixer
主体材质: 铜 / Material: Brass

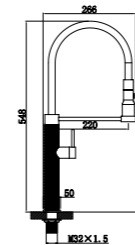

C B Q LG



25510
单把抽拉厨房龙头
Pull-out kitchen mixer
主体材质: 铜 / Material: Brass

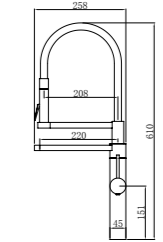

C B Q LG



25503
单把抽拉厨房龙头
Pull-out kitchen mixer
主体材质: 铜 / Material: Brass

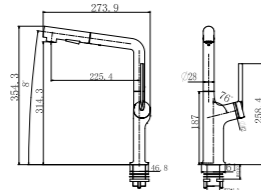

C B W Q LG M



25504
单把抽拉厨房龙头
Pull-out kitchen mixer
主体材质: 铜 / Material: Brass

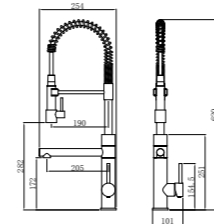

C B Q LG



25511
单把抽拉厨房龙头
Pull-out kitchen mixer
主体材质: 铜 / Material: Brass

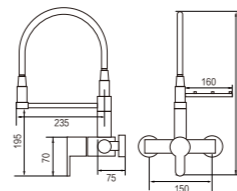

C B Q L



25512
单把抽拉厨房龙头
Pull-out kitchen mixer
主体材质: 铜 / Material: Brass

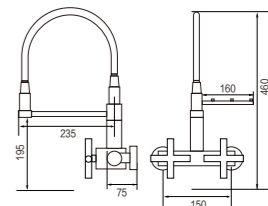

C B Q L



25505
单把抽拉厨房龙头
Pull-out kitchen mixer
主体材质: 铜 / Material: Brass

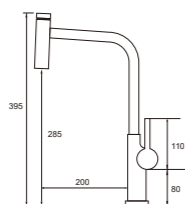

C L B W Q LG



25506
单把抽拉厨房龙头
Pull-out kitchen mixer
主体材质: 铜 / Material: Brass

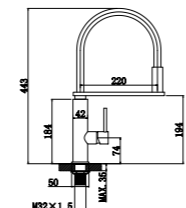

C



25513
单把抽拉厨房龙头
Pull-out kitchen mixer
主体材质: 锌 / Material: Zinc

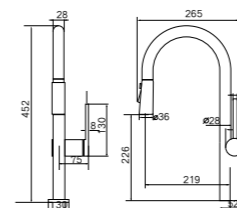

C B W Q LG L N



25514
单把抽拉厨房龙头
Pull-out kitchen mixer
主体材质: 锌 / Material: Zinc

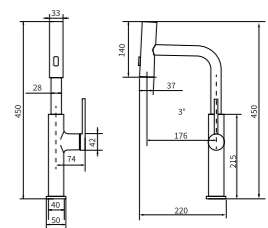

C B W Q LG L



25515
单把抽拉厨房龙头
Pull-out kitchen mixer
主体材质: 铜 /Material: Brass
C B Q



25516
单把抽拉厨房龙头
Pull-out kitchen mixer
主体材质: 铜 /Material: Brass
C B Q LG



25517
单把抽拉厨房龙头
Pull-out kitchen mixer
主体材质: 铜 /Material: Brass
C B W Q



25518
单把抽拉厨房龙头
Pull-out kitchen mixer
主体材质: 铜 /Material: Brass
C W Q



25527
单把抽拉厨房龙头
Pull-out kitchen mixer
主体材质: 铜 /Material: Brass
C Q



25528
单把抽拉厨房龙头
Pull-out kitchen mixer
主体材质: 铜 + 锌 /Material: Brass+Zinc
C B L W Q



25529
单把抽拉厨房龙头
Pull-out kitchen mixer
主体材质: 铜 + 锌 /Material: Brass+Zinc
C B L W Q



25530
单把抽拉厨房龙头
Pull-out kitchen mixer
主体材质: 铜 + 锌 /Material: Brass+Zinc
C B Q



25519 双水路净水
单把抽拉厨房龙头
Pull-out kitchen mixer
主体材质: 铜 /Material: Brass
C L B W Q LG



25520 双水路净水
单把抽拉厨房龙头
Pull-out kitchen mixer
主体材质: 铜 /Material: Brass
C L B W Q LG



25521 双水路净水
单把抽拉厨房龙头
Pull-out kitchen mixer
主体材质: 铜 /Material: Brass
C L B W Q LG



25522
单把抽拉厨房龙头
Pull-out kitchen mixer
主体材质: 铜 /Material: Brass
C Q



25531
单把抽拉厨房龙头
Pull-out kitchen mixer
主体材质: 铜 + 锌 /Material: Brass+Zinc
C B L W Q



25532
单把抽拉厨房龙头
Pull-out kitchen mixer
主体材质: 铜 + 锌 /Material: Brass+Zinc
C B L W Q



25533
单把抽拉面盆龙头
Pull-out Basin Mixer
主体材质: 铜 + 锌 /Material: Brass+Zinc
C L B W Q



25534
单把抽拉厨房龙头
Pull-out kitchen mixer
主体材质: 铜 + 锌 /Material: Brass+Zinc
C L B W Q



25523
单把抽拉厨房龙头
Pull-out kitchen mixer
主体材质: 铜 /Material: Brass
C L B W Q



25524
单把折叠厨房龙头
Fold kitchen mixer
主体材质: 铜 /Material: Brass
C L



25525
单把折叠厨房龙头
Fold kitchen mixer
主体材质: 铜 /Material: Brass
C L



25526
单把折叠厨房龙头
Fold Kitchen Mixer
主体材质: 铜 /Material: Brass
B LG



25535
单把抽拉厨房龙头
Pull-out kitchen mixer
主体材质: 铜 + 锌 /Material: Brass+Zinc
C W Q



25536
单把抽拉厨房龙头
Pull-out kitchen mixer
主体材质: 铜 + 锌 /Material: Brass+Zinc
C W Q



25537
单把抽拉厨房龙头
Pull-out kitchen mixer
主体材质: 铜 /Material: Brass
C B Q W



25538
单把抽拉厨房龙头
Pull-out kitchen mixer
主体材质: 铜 /Material: Brass
C B Q LG



25539
单把抽拉厨房龙头
Pull-out kitchen mixer
主体材质: 铜 + 锌 /Material: Brass+Zinc
C B W Q LG BM BG



25540
单把抽拉厨房龙头
Pull-out kitchen mixer
主体材质: 铜 + 锌 /Material: Brass+Zinc
C B W Q LG BM BG



25541
单把抽拉厨房龙头
Pull-out kitchen mixer
主体材质: 铜 + 锌 /Material: Brass+Zinc
C B W Q LG N



25542
单把抽拉厨房龙头
Pull-out kitchen mixer
主体材质: 铜 + 锌 /Material: Brass+Zinc
C B W Q LG N



26001
单把面盆龙头
Single handle basin faucet
主体材质: 铜 /Material: Brass

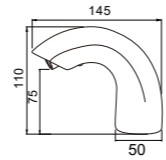

26002
单把面盆龙头
Single handle basin faucet
主体材质: 铜 /Material: Brass

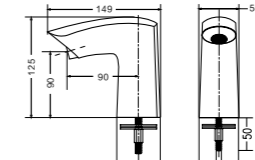

26003
单把面盆龙头
Single handle basin faucet
主体材质: 铜 /Material: Brass

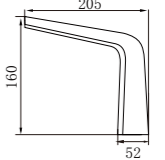

25543
单把抽拉厨房龙头
Pull-out kitchen mixer
主体材质: 铜 /Material: Brass
C B W Q LG



25544
单把抽拉厨房龙头
Pull-out kitchen mixer
主体材质: 铜 + 锌 /Material: Brass+Zinc
C B L W Q



25545
单把抽拉厨房龙头
Pull-out kitchen mixer
主体材质: 铜 + 锌 /Material: Brass+Zinc
L Q



25546
单把抽拉厨房龙头
Pull-out kitchen mixer
主体材质: 铜 + 锌 /Material: Brass+Zinc
L Q



26004
单把面盆龙头
Single handle basin faucet
主体材质: 铜 /Material: Brass

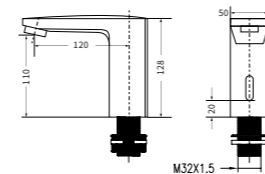

26005
单把面盆龙头
Single handle basin faucet
主体材质: 铜 /Material: Brass

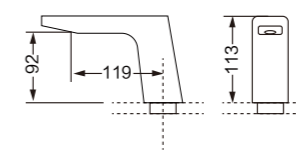

26006
单把面盆龙头
Single handle basin faucet
主体材质: 铜 /Material: Brass

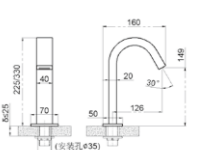

25547
单把抽拉厨房龙头
Pull-out kitchen mixer
主体材质: 铜 + 锌 /Material: Brass+Zinc
C B Q



25548
单把抽拉厨房龙头
Pull-out kitchen mixer
主体材质: 铜 + 锌 /Material: Brass+Zinc
C B L W Q



25549
单把抽拉厨房龙头
Pull-out kitchen mixer
主体材质: 铜 + 锌 /Material: Brass+Zinc
C B L W Q



25550
单把抽拉厨房龙头
Pull-out kitchen mixer
主体材质: 铜 + 锌 /Material: Brass+Zinc
C B L W Q



26007
单把面盆龙头
Single handle basin faucet
主体材质: 铜 /Material: Brass

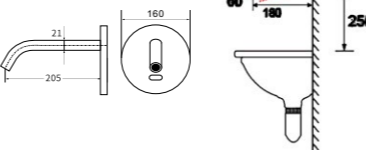

26008
单把面盆龙头
Single handle basin faucet
主体材质: 铜 /Material: Brass

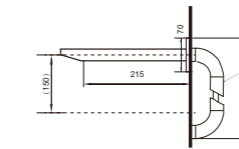

26009
单把面盆龙头
Single handle basin faucet
主体材质: 铜 /Material: Brass

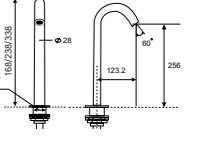



26101
马桶伴侣
Toilet Companion
主体材质: 铜 /Material: Brass
C B Q



26102
马桶伴侣
Toilet Companion
主体材质: 铜 /Material: Brass
C B Q



26103
马桶伴侣
Toilet Companion
主体材质: 铜 /Material: Brass
C B W Q LG M



26104
水嘴
Water spout
主体材质: 铜 /Material: Brass
C B W Q LG M



26113
角阀
Angle valve
主体材质: 铜 /Material: Brass
C B W Q LG



26114
角阀
Angle valve
主体材质: 铜 /Material: Brass
C B W Q LG



26115
角阀
Angle valve
主体材质: 铜 /Material: Brass
C B W Q LG



26116
角阀
Angle valve
主体材质: 铜 /Material: Brass
C B W Q LG



26105
马桶伴侣
Toilet Companion
主体材质: 铜 /Material: Brass
C B Q



26106
马桶伴侣
Toilet Companion
主体材质: 铜 /Material: Brass
C B Q



26107
马桶伴侣
Toilet Companion
主体材质: 铜 /Material: Brass
C B Q



26108
马桶伴侣
Toilet Companion
主体材质: SUS304 /Material: SUS304
C B W Q



26117
角阀
Angle valve
主体材质: 铜 /Material: Brass
C B W Q LG G M



26118
角阀
Angle valve
主体材质: 铜 /Material: Brass
C B W Q LG



26119
角阀
Angle valve
主体材质: 铜 /Material: Brass
C B W Q LG



26120
角阀
Angle valve
主体材质: 铜 /Material: Brass
C B W Q LG



26109
水嘴
Water spout
主体材质: 铜 /Material: Brass
C B Q LG



26110
水嘴
Water spout
主体材质: 铜 /Material: Brass
C Q



26111
水嘴
Water spout
主体材质: 铜 /Material: Brass
C Q



26112
马桶伴侣
Toilet Companion
主体材质: 铜 /Material: Brass
C B W Q LG



26121
角阀
Angle valve
主体材质: 铜 /Material: Brass
C B W Q LG G M



26122
角阀
Angle valve
主体材质: 铜 /Material: Brass
C B W Q LG



26123
角阀
Angle valve
主体材质: 铜 /Material: Brass
C B W Q LG M



26124
角阀
Angle valve
主体材质: 铜 /Material: Brass
C B W Q LG



26125

角阀

Angle valve

主体材质：铜 /Material: Brass



26126

角阀

Angle valve

主体材质：铜 /Material: Brass



26127

水嘴

Water spout

主体材质：铜 /Material: Brass



26128

水嘴

Water spout

主体材质：铜 /Material: Brass



INTELLIGENT



26129

水嘴

Water spout

主体材质：铜 /Material: Brass



26130

水嘴

Water spout

主体材质：铜 /Material: Brass

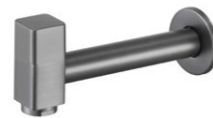

26131

水嘴

Water spout

主体材质：铜 /Material: Brass

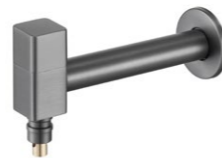

26132

水嘴

Water spout

主体材质：铜 /Material: Brass



26133

水嘴

Water spout

主体材质：铜 /Material: Brass



26134

水嘴

Water spout

主体材质：铜 /Material: Brass



26135

水嘴

Water spout

主体材质：铜 /Material: Brass



26136

水嘴

Water spout

主体材质：铜 /Material: Brass



IT IS COLD
AND
STYLISH

电热毛巾架

towel rack

It is cold and stylish, elegant and mysterious.
Absorbing natural light also attracts eye-catching eyes.
In addition, excellent performance, not just looking
beautiful, More beautiful to do more for you.



27001

电热毛巾架

Electric towel rack

主体材质 :SUS304/Material: SUS304

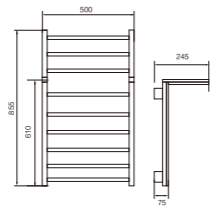

27002

电热毛巾架

Electric towel rack

主体材质 :SUS304/Material: SUS304

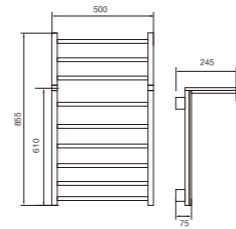

27009

电热毛巾架

Electric towel rack

主体材质 :SUS304/Material: SUS304

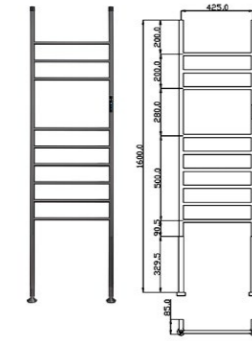
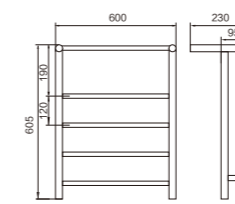

27010

电热毛巾架

Electric towel rack

主体材质 :SUS304/Material: SUS304



27003

电热毛巾架

Electric towel rack

主体材质 :SUS304/Material: SUS304

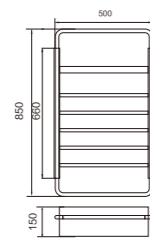

27004

电热毛巾架

Electric towel rack

主体材质 :SUS304/Material: SUS304

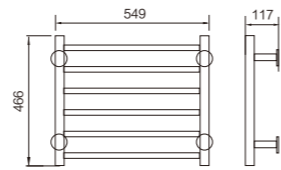

27011

电热毛巾架

Electric towel rack

主体材质 :SUS304/Material: SUS304

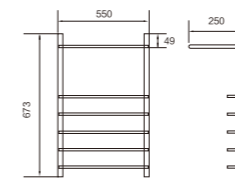

27012

电热毛巾架

Electric towel rack

主体材质 :SUS304/Material: SUS304

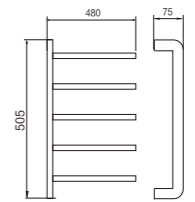

27005

电热毛巾架

Electric towel rack

主体材质 :SUS304/Material: SUS304

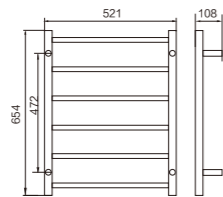

27006

电热毛巾架

Electric towel rack

主体材质 :SUS304/Material: SUS304

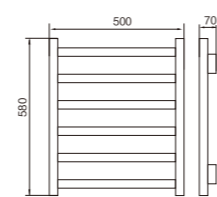

27013

电热毛巾架

Electric towel rack

主体材质 :SUS304/Material: SUS304

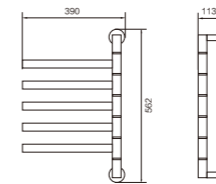

27014

电热毛巾架

Electric towel rack

主体材质 :SUS304/Material: SUS304

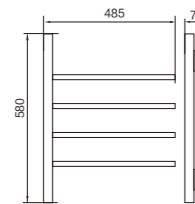

27007

电热毛巾架

Electric towel rack

主体材质 :SUS304/Material: SUS304

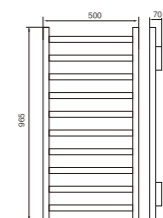

27008

电热毛巾架

Electric towel rack

主体材质 :SUS304/Material: SUS304

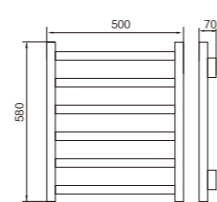



27015
电热毛巾架
Electric towel rack
主体材质 :SUS304/Material: SUS304

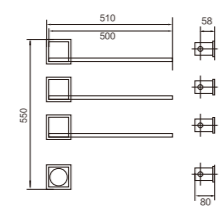

27016
电热毛巾架
Electric towel rack
主体材质 :SUS304/Material: SUS304

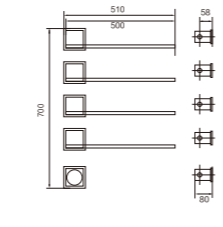

27023
电热毛巾架
Electric towel rack
主体材质 :SUS304/Material: SUS304

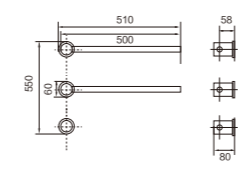

27024
电热毛巾架
Electric towel rack
主体材质 :SUS304/Material: SUS304

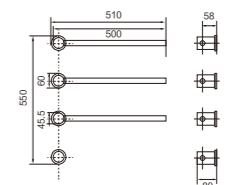

27017
电热毛巾架
Electric towel rack
主体材质 :SUS304/Material: SUS304

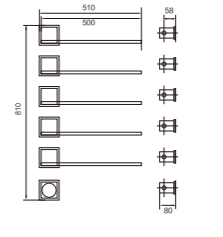

27018
电热毛巾架
Electric towel rack
主体材质 :SUS304/Material: SUS304

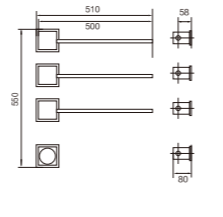

27025
电热毛巾架
Electric towel rack
主体材质 :SUS304/Material: SUS304

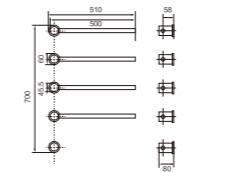

27026
电热毛巾架
Electric towel rack
主体材质 :SUS304/Material: SUS304

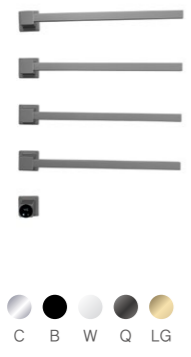
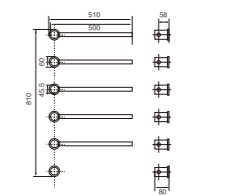

27019
电热毛巾架
Electric towel rack
主体材质 :SUS304/Material: SUS304

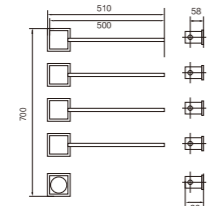

27020
电热毛巾架
Electric towel rack
主体材质 :SUS304/Material: SUS304

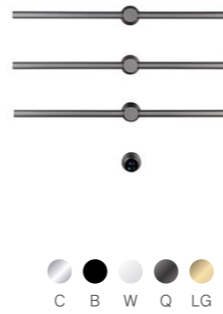
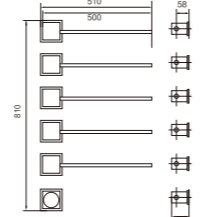

27027
电热毛巾架
Electric towel rack
主体材质 :SUS304/Material: SUS304

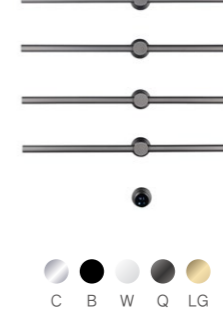
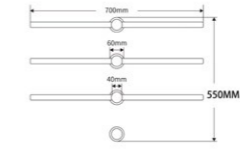

27028
电热毛巾架
Electric towel rack
主体材质 :SUS304/Material: SUS304

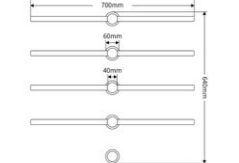

27021
发光置物架
Luminous storage rack
主体材质 :SUS304/Material: SUS304

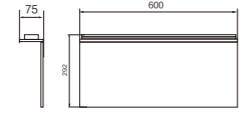

27022
电热毛巾架
Electric towel rack
主体材质 :SUS304/Material: SUS304

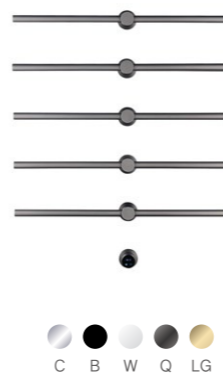
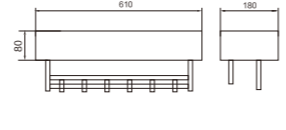

27029
电热毛巾架
Electric towel rack
主体材质 :SUS304/Material: SUS304

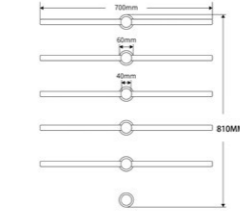

27030
电热毛巾架
Electric towel rack
主体材质 :SUS304/Material: SUS304

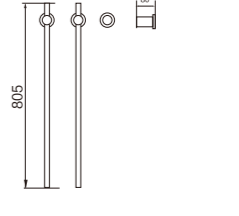



H 型防护设计 . 置物不掉落

STORAGE RACK. TOWEL RACK

高颜值 . 高强度 . 高承重 . 颜色多 . 可定制 . 易清洁 .



27101
多功能置物架
Multi functional storage rack
主体材质 : SUS304 / Material : SUS304

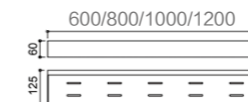

- C
- B
- W
- Q
- LG
- M



27102
多功能置物架
Multi functional storage rack
主体材质 : 太空铝 / Material : Space aluminum

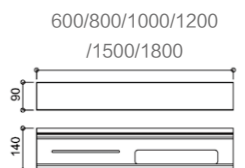

- C
- B
- W
- Q
- LG
- M

主体材质 :SUS304/Material: SUS304

● 亮铬 Chrome ● 枪灰 Gun grey ● 雅黑 Matte black ● 拉丝金 Brushed gold



27111
衣钩
Clothes hook



27112
毛巾环
Towel loop



27113
毛巾环
Towel ring



27114
马桶刷
Toilet brush



27115
单杆
Single pole

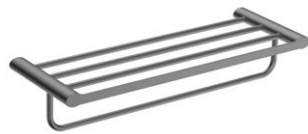

27116
浴巾架
Bath towel holder



27121
衣钩
Clothes hook



27122
衣钩
Clothes hook

主体材质 :SUS304/Material: SUS304

● 亮铬 Chrome ● 枪灰 Gun grey ● 雅黑 Matte black ● 拉丝金 Brushed gold



27123
毛巾环
Towel loop



27124
双杆
Double pole



27125
毛巾架
Towel rack



27126
毛巾架
Towel rack



27127
单杆
Single pole



27128
置物架
Storage rack



27129
浴巾架
Bath towel holder



27130
马桶刷
Toilet brush



主体材质：铜 + 不锈钢 /Material: Brass+stainless steel

● 亮铬 Chrome ● 枪灰 Gun grey ● 拉丝金 Brushed gold ● 雅黑 + 拉丝金 Matte black+Brushed gold



27131
杯架
Cup holder



27132
碟架
Cup holder



27133
皂篮
Soap basket



27134
纸巾架
Toilet paper holder



27135
衣钩
Clothes hook



27136
衣钩
Clothes hook



27137
毛巾环
Towel loop



27138
毛巾环
Towel loop



27139
单杆
Single pole



27140
双杆
Double pole



27141
浴巾架
Bath towel holder



27142
马桶刷
Toilet brush



27143
杯架
Cup holder



27144
碟架
Cup holder



27145
皂液器
Soap dispenser



27146
马桶刷
Toilet brush

主体材质：锌合金 + 钢 /Material: Zinc alloy+steel

● 亮铬 Chrome ● 枪灰 Gun grey



27151
杯架
Cup holder

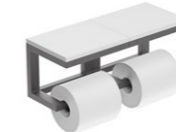

27152
纸巾架
Toilet paper holder

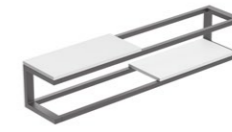

27153
置物架
Storage rack



27154
马桶刷
Toilet brush

主体材质：SUS304 /Material: SUS304

● 亮铬 Chrome ● 枪灰 Gun grey ● 雅黑 Matte black



27161
毛巾环
Towel loop



27162
单杆
Single pole



27163
浴巾架
Bath towel holder



27164
马桶刷
Toilet brush

主体材质：SUS304 /Material: SUS304

● 亮铬 Chrome



27165
纸巾架
Toilet paper holder

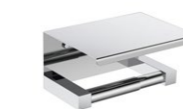

27166
纸巾架
Toilet paper holder



27167
纸巾架
Toilet paper holder



27168
纸巾架
Toilet paper holder



27169
纸巾架
Toilet paper holder



27170
纸巾架
Toilet paper holder



27171
纸巾架
Toilet paper holder



27172
纸巾架
Toilet paper holder

● B ● Q

材质: 锌 + 不锈钢 / Material: Zinc+Stainless Steel

● 亮铬 Chrome ● 枪灰 Gun grey ● 玫瑰金 Rose Gold



27181
毛巾环
Towel loop



27182
纸巾架
Toilet paper holder



27183
纸巾架
Toilet paper holder



27184
吹风机架
Hair dryer holder



27185
单杆
Single pole



27186
双杆
Double pole



27187
浴巾架
Bath towel holder



27188
马桶刷
Toilet brush



材质: 锌 + 不锈钢 / Material: Zinc+Stainless Steel

● 亮铬 Chrome ● 雅黑 Matte black



27191
衣钩
Clothes hook



27192
毛巾环
Towel loop



27193
纸巾架
Toilet paper holder



27194
吹风机架
Hair dryer holder



27195
纸巾架
Toilet paper holder



27196
单杆
Single pole



27197
双杆
Double pole



27198
浴巾架
Bath towel holder



27199
置物架
Storage rack



27200
马桶刷
Toilet brush

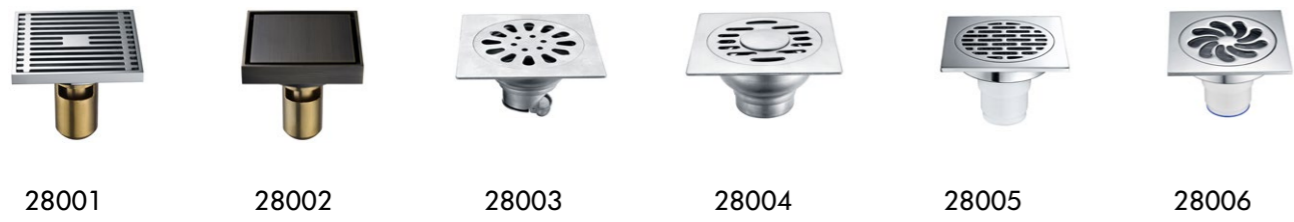

28001 28002 28003 28004 28005 28006

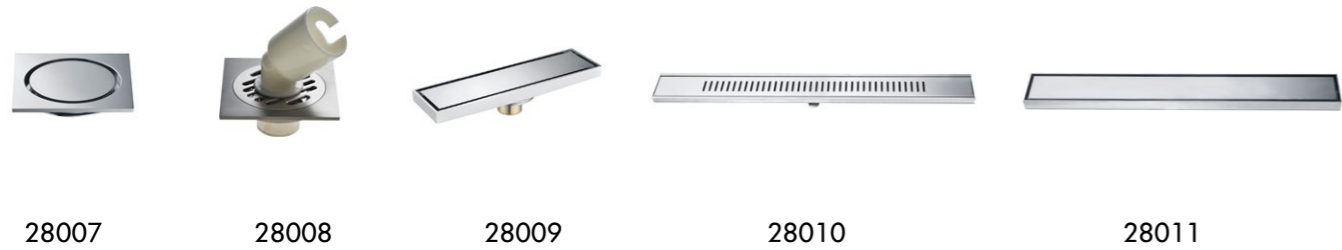

28007 28008 28009 28010 28011

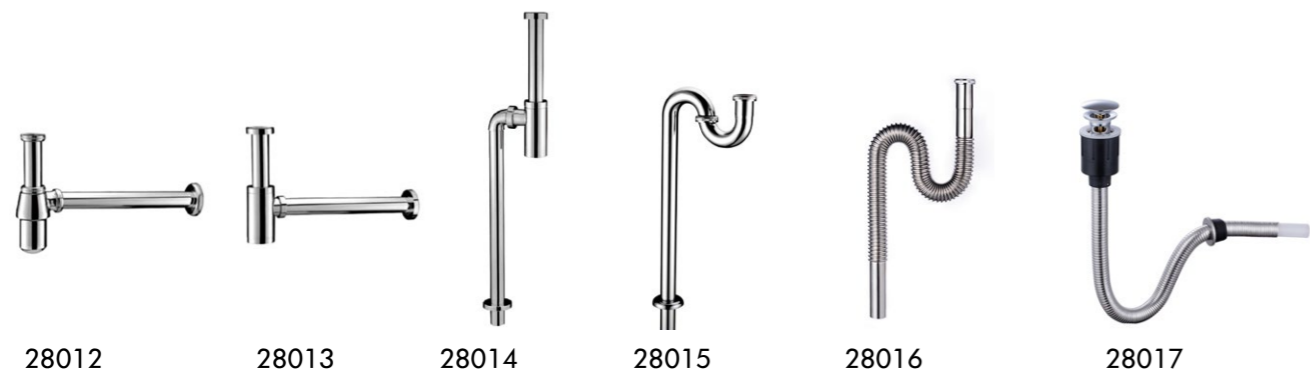

28012 28013 28014 28015 28016 28017



28022 28023 28024 28018 28019 28020 28021
28025 28026 28027 28028

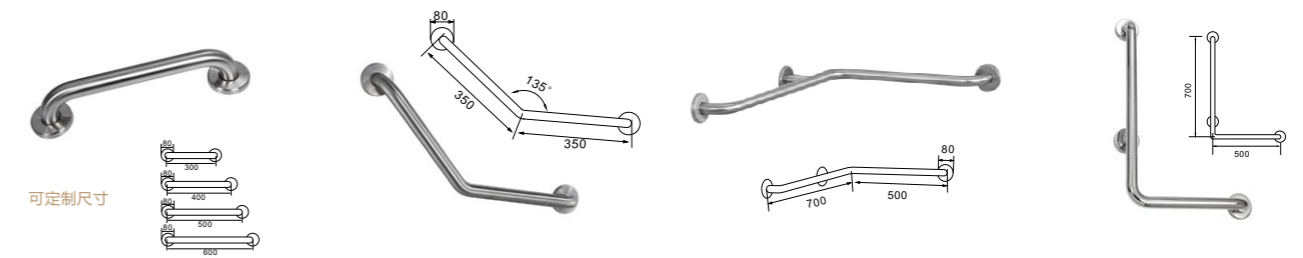

可定制尺寸

28029 28030 28031 28032
安全扶手 安全扶手 安全扶手 安全扶手
Safety handrails Safety handrails Safety handrails Safety handrails
主体材质 :SUS304/Material: SUS304 主体材质 :SUS304/Material: SUS304 主体材质 :SUS304/Material: SUS304 主体材质 :SUS304/Material: SUS304

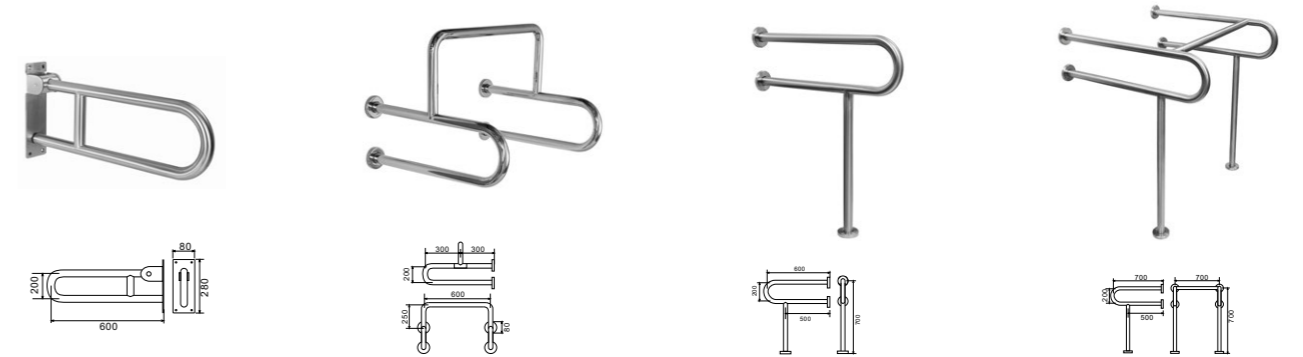

28033 28034 28035 28036
安全扶手 安全扶手 安全扶手 安全扶手
Safety handrails Safety handrails Safety handrails Safety handrails
主体材质 :SUS304/Material: SUS304 主体材质 :SUS304/Material: SUS304 主体材质 :SUS304/Material: SUS304 主体材质 :SUS304/Material: SUS304



28037 28038 28039 28040



28041 28042 28043 28044



BJ-130
化妆镜 /Cosmetic mirror
铬色 /Chrome



DJ-083-LED
化妆镜 /Cosmetic mirror
铬色 /Chrome



BJ-085
化妆镜 /Cosmetic mirror
玫瑰金 /Rose gold



DJ-019-LED
化妆镜 /Cosmetic mirror
拉丝金 /Brushed gold



DJ-036-LED
化妆镜 /Cosmetic mirror
哑黑 /Matt black



BJ-114
化妆镜 /Cosmetic mirror
铬色 /Chrome



DJ-021-LED
化妆镜 /Cosmetic mirror
珍珠白 /Pearl white



DJ-023-LED (亚克力)
化妆镜 /Cosmetic mirror
拉丝金 /Brushed gold

红外线感应



DJ-026-LED
化妆镜 /Cosmetic mirror
铬色 /Chrome



TOUCH DIMMING BUTTON

Short touch on the button: on/
off the light long Touch on the
button: dimming the light

DJ-095-LED
化妆镜 /Cosmetic mirror
铬色 /Chrome



BJ-201
化妆镜 /Cosmetic mirror
铬色 /Chrome



BJ-204
化妆镜 /Cosmetic mirror
铬色 /Chrome



BJ-212
化妆镜 /Cosmetic mirror
铬色 /Chrome

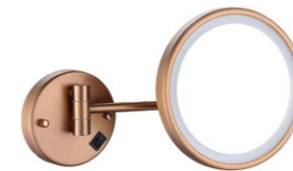

DJ-031-LED
化妆镜 /Cosmetic mirror
玫瑰金 /Rose gold



BJ-224
化妆镜 /Cosmetic mirror
亮黑 /Black



BJ-214
化妆镜 /Cosmetic mirror
铬色 /Chrome